



JK Chrome

JK Chrome | Employment Portal



Rated No.1 Job Application of India

Sarkari Naukri
Private Jobs
Employment News
Study Material
Notifications



JOBS



NOTIFICATIONS



G.K



STUDY MATERIAL



JK Chrome

jk chrome
Contains ads



www.jkchrome.com | Email : contact@jkchrome.com

SSC GD

Reasoning

1. Study the given pattern carefully and select the number that can replace the question mark (?) in it.

14 12 15
11 17 16
180 234 ?

- A 272
- B 369
- C 298
- D 425

Answer: A

2. In a certain code language, the word 'DISK' is written as 'LTJE'. How will 'SFWP' be written in that language?

- A REVO
- B TGXQ
- C OVER
- D QXGT

Answer: C

3. 'Monarch' is related to 'Butterfly' in the same way as 'Mamba' is related to '_____'.
(Note: A large watermark 'JKCHROME.COM' is overlaid on this section.)

- A Venom
- B Snake
- C Queen
- D Royal

Answer: B

4. Select the figure from among the given options that can replace the question mark (?) in the following series.

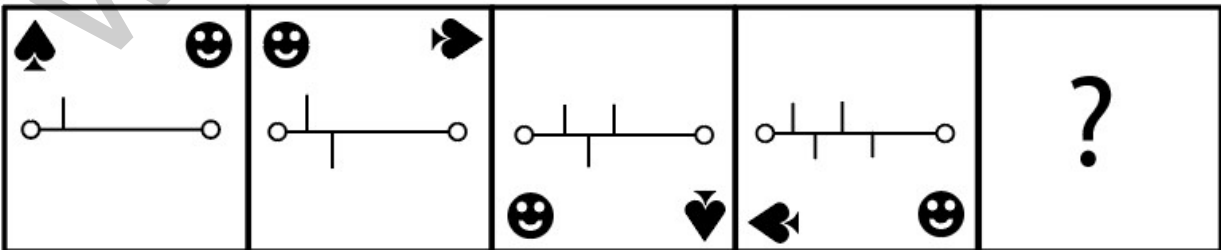

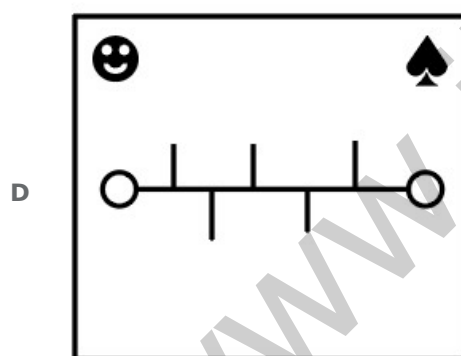
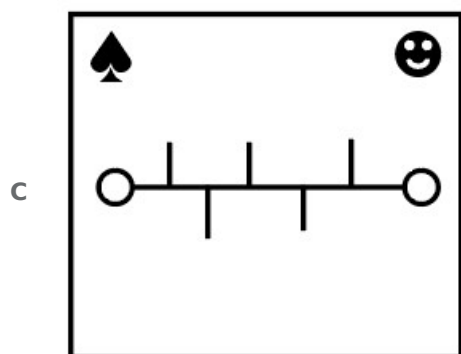
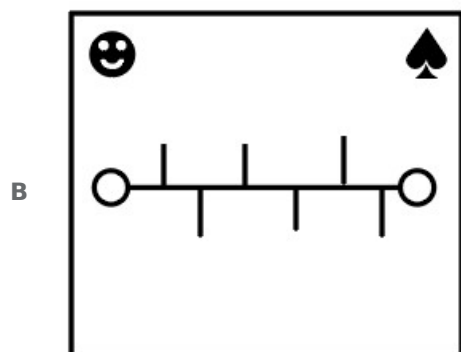
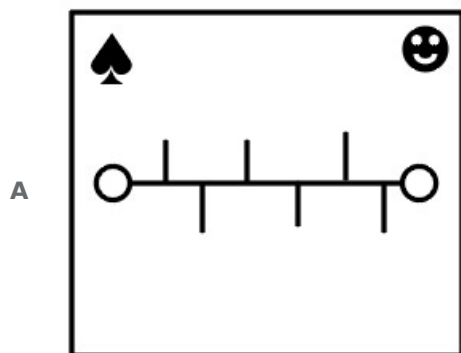

Answer: C

5. Select the option that is related to the fourth number in the same way as the first number is related to the second number and the fifth number is related to the sixth number.

4523 : 22 :: ? : 14 :: 9178 : 13

A 8228

B 7448

C 9152

D 5440

Answer: D

6. Select the correct option that indicates the arrangement of the given words in the order in which they appear in an English dictionary.

- 1. Congrats
- 2. Confusion
- 3. Confound
- 4. Congregate
- 5. Confucian

A 3, 2, 5, 1, 4

B 3, 5, 2, 1, 4

C 3, 1, 4, 5, 2

D 3, 4, 1, 5, 2

Answer: B

7. A paper sheet is folded in a particular manner and several punches are made. When unfolded the paper sheet looks like the question figure. From the given options, select the figure that follows the manner in which the paper is folded and punched.

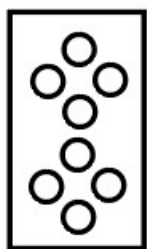

A

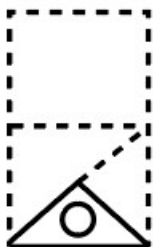

B

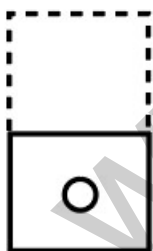

C

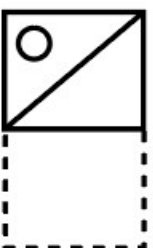

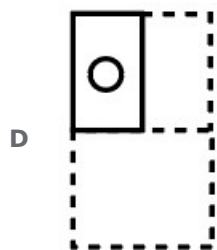

Answer: A

8. Which two signs should be interchanged to make the given equation correct?

$$15 \times 6 + 132 - 11 \div 44 = 58$$

- A + and \times
- B + and \div
- C \div and $-$
- D \times and \div

Answer: C

9. Select the option that is related to the third letter-cluster in the same way as the second letter-cluster is related to the first letter-cluster.

PVSD : TYUE :: DPKR : ?

- A GTNS
- B HTMS
- C HSMS
- D ISNS

Answer: C

10. Select the option in which the given figure is embedded (rotation is NOT allowed).



A

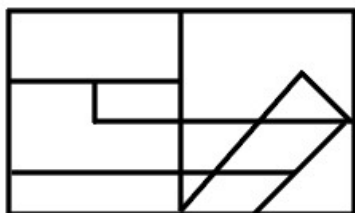

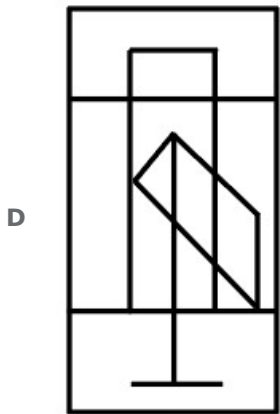
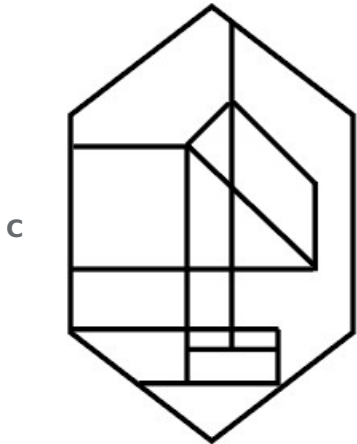

Answer: C

11. Select the correct mirror image of the given figure when the mirror is placed at 'XY' as shown.

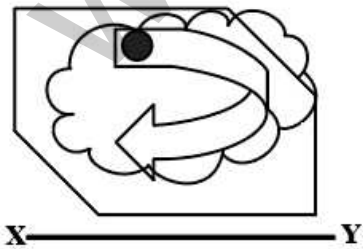

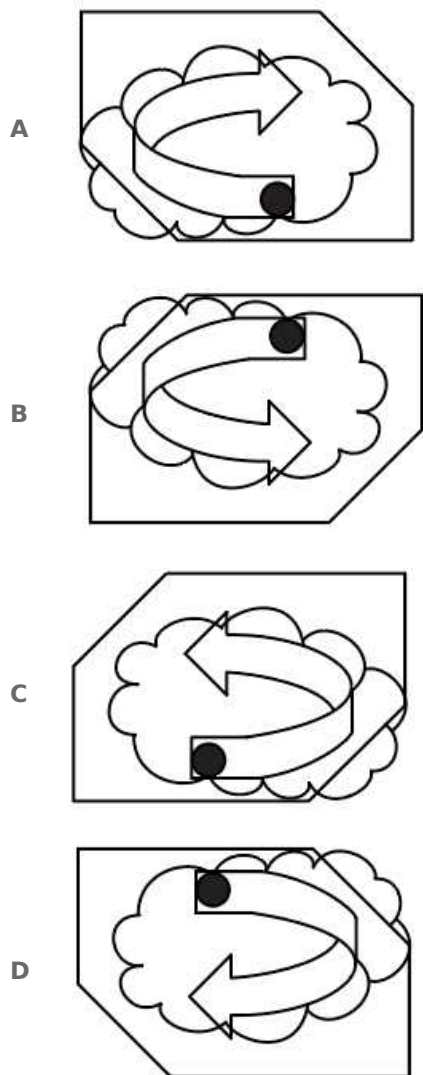

Answer: C

12. Select the set of classes the relationship among which is best illustrated by the given Venn diagram .



- A** Citizen, Uneducated Advocates
- B** Brothers Cricketers, !en
- C** Sofa, Flurniture, Book
- D** Sharks, Whales, Toads

Answer: A

13. Five persons are sitting in a row. D and H are the two persons at the extreme end. L is to the right of P. T is to the left of the H. What is the position of L from the left?

- A** First
- B** Second

- C Third
- D Fourth

Answer: C

14. Select the letter-cluster from among the given options that can replace the question mark (?) in the following series.

GLQ, VAF, KPU, ZEJ, ?

- A OUZ
- B OTY
- C PTY
- D PUY

Answer: B

15. Select the number from among the given options that can replace the question mark (?) in the following series.

14, 14, 15, 23, 87, 212, ?

- A 482
- B 428
- C 284
- D 248

Answer: B

16. Four letter-clusters have been given, out of which three are alike in some manner and one is different. Select the odd one.

- A RNJF
- B XTPL
- C MIEA
- D TPLI

Answer: D

17. Select the number from among the given options that can replace the question mark (?) in the following series.

6, 5, 7, 7, 10, 11, 15, 17, ?

- A 22
- B 25
- C 24
- D 23

Answer: A

18. Eight friends, A, B, C, D, E, F, G and H, are sitting clockwise around a circular table in the same sequence, facing the centre, at equal distance between them. C is facing the north direction. Now if D leaves his place and a new friend Y occupies D's place, then which of the following two persons are sitting opposite each other?

- A Y and B
- B C and H
- C B and F
- D F and A

Answer: C

19. Pointing to Kiran, Rohan says, "She is the daughter of the only son of my grandfather." How is Kiran related to Rohan?

- A Mother
- B Daughter-in-law
- C Wife
- D Sister

Answer: D

20. Select the combination of letters that when sequentially placed in the blanks of the given series will complete the series.
KP_LMK_TL_KPT_M_PT_M

- A T, P, M, L, K, L
- B P, K, L, T, M, L
- C P, T, L, K, M, L
- D T, P, L, M, L, K

Answer: A

21. Read the given statements and conclusions carefully. Assuming that the information given in the statements is true, even if it appears to be at variance with commonly known facts, decide which of the given conclusions logically follow(s) from the statements.

Statements:

- I. All grills are ovens.
- II. Some tandoors are grills.

Conclusions:

- I. Some tandoors are oven.
- II. All ovens are tandoor.

- A Only conclusion II follows.
- B Only conclusion I follows.
- C Both conclusions I and II follow.

- D** Neither conclusion I nor II follows.

Answer: B

22. In a certain code language, MORALE is coded as 1315181125. How will VALUES be coded in that language?

- A** 2211221519
B 1951221122
C 2121212519
D 1125185131

Answer: A

23. In a certain code language, 'HEROIC' is written as 'KBULLZ'. How will 'VALIANT' be written in that language?

- A** YXOLXQQ
B YXOFDKW
C YXOEDLW
D TCJLYPS

Answer: B

24. A cube is made by folding the given sheet. In the cube so formed, which pair of symbols will be on opposite faces?

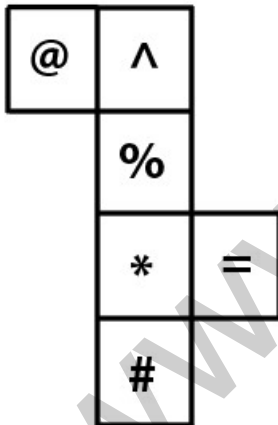

- A** # and =
B @ and %
C @ and =
D % and *

Answer: C

25. How many terms of the series 53, 57, 61, 65 Need to be taken so that their sum is 1106?

- A 15
- B 20
- C 14
- D 21

Answer: C

General knowledge

26. In which year was the Sahitya Akademi Award started?

- A 1955
- B 1954
- C 1956
- D 1953

Answer: B

27. In which year was the English Education Act introduced to make English the medium of instruction for higher education and to stop the promotion of oriental institutions?

- A 1835
- B 1830
- C 1854
- D 833

Answer: A

28. Who among the following sportspersons received the prestigious Rajiv Gandhi Khel Ratna Award in August 2020?

- A Atanu Das
- B Mariyappan T
- C Naresh Kumar
- D Romesh Pathania

Answer: B

29. Which of the following insects has a pigment called 'luciferin'?

- A Butterfly
- B Redfly

C Nightfly

D Firefly

Answer: D

30. Who was appointed as the director of the Indian National Centre for Ocean Information System in 2020?

A Vinay Mohan Kwatra

B Srinivasa Kumar Tummala

C BV Satyanarayana

D S Nageswara Rao

Answer: B

31. Which of the following is a water-borne disease?

A Cholera

B Common cold

C Mumps

D Pneumonia

Answer: A

32. Which among the following became the first Indian Airport to launch an e-boarding facility for passengers on International flights?

A GMR Hyderabad International Airport

B Indira Gandhi International Airport, Delhi

C Sardar Vallabhbhai Patel International Airport, , Gujarat

D Dabolim Airport, Goa

Answer: A

33. Which of the following terms is used to describe the outside layer of skin on the human body?

A Keratin

B Larynx

C Epidermis

D Quadriceps

Answer: C

34. In Australian Open 2020 Tennis Tournament who won the Men's Singles title?

- A Rafael Nadal
- B Dominic Thiem
- C Alexander Zverev
- D Novak Djokovic

Answer: D

35. Salal Hydroelectric Power Station is built on which of the following rivers?

- A Chenab
- B Bhagirathi
- C Jhelum
- D Kosi

Answer: A

36. The Cabinet Committee on Economic Affairs (CCEA) announced the highest increase in (MSP) for ____ for the Rabi Marketing Season 2020-21.

- A wheat
- B mustard
- C barley
- D lentil

Answer: D

37. The 'Pattachitra' style of painting is a popular art form associated with the state of:

- A Bihar
- B Rajasthan
- C Odisha
- D Uttar Pradesh

Answer: C

38. Which of the following is a famous Tamil epic composed by Ilango in ancient India?

- A Shishupala Vadha
- B Silappadikaram
- C Aitareya Brahmana

D Ramacharitam

Answer: B

39. In October 2020, investment promotion and facilitation agency Guidance partnered with World Economic Forum (WEF) to establish India's first advanced manufacturing hub (AMHUB) in the state of _____.

A Tamil Nadu

B Karnataka

C Kerala

D Andhra Pradesh

Answer: A

40. SLR determines the amount of money a bank needs to invest in certain specified securities, which are predominantly securities issued by the central and state governments. What is the full form of SLR?

A Statutory Liquidity Reserve

B Statutory Liquidity Ratio

C Statement Liquidity Ratio

D Statutory Liquidity Rate

Answer: B

41. Which Indian player won the BBC Indian Sportswoman of the Year 2019?

A Manasi Joshi

B PV Sindhu

C Mary Kom

D Vinesh Phogat

Answer: B

42. According to the Constitution of India, which of the following statements is correct?

A The Legislature is a small group of people.

B The Executive refers to our elected representatives.

C The Legislature, Executive and the Judiciary should exercise same powers.

D The Judiciary refers to the system of courts in the country.

Answer: D

43. The Nobel Peace Prize 2020 was awarded to:

- A International Monetary Fund
- B Amnesty International
- C World Food Programme
- D World Health Organization

Answer: C

44. A 'charkha' was placed at the centre of the tricolour flag of the Indian National Congress adopted in the year ____.

- A 1929
- B 1931
- C 1938
- D 1926

Answer: B

45. What was India's rank in the Emerging Green Bond Market as per Economic Survey 2019-20?

- A First
- B Fourth
- C Second
- D Third

Answer: C

46. Dashain is a famous festival which originated from ____.

- A Myanmar
- B India
- C Nepal
- D Bhutan

Answer: C

47. Which of the following is India's highest (tallest) dam?

- A Sardar Sarovar Dam, Gujarat
- B Hirakud Dam, Odisha
- C Tehri Dam, Uttarakhand
- D Bhakra Nangal Dam, Himachal Pradesh

Answer: C

48. How many fundamental rights and fundamental duties are prescribed in the Constitution of India?

- A Seven and eleven, respectively
- B Seven and ten, respectively
- C Six and eleven, respectively
- D Eight and ten, respectively

Answer: C

49. In 1977, the Government of Bengal erected its first statue dedicated to a female freedom fighter in Kolkata Maidan. What was her name?

- A Aruna Asaf Ali
- B Matangini Hazra
- C Kanaklata Barua
- D Bhika ji Cama

Answer: B

50. In which year did India sign an agreement with International Seabed Authority for exploratory mining?

- A 2000
- B 2002
- C 2003
- D 2001

Answer: B

Quantitative Ability

51. 4 years ago, the average age of a family of 4 members was 19 years. A baby having been born, the average age of the family is the same today. Find the present age of the baby.

- A 4 years
- B 2 years
- C 1 years
- D 3 years

Answer: D

52. The average of 9 numbers is 51. Average of three of them is 49 and average of four of the remaining numbers is 46. What is the average of the remaining numbers?

- A 54
- B 64
- C 63
- D 62.5

Answer: B

53. The marked price of a bed sheet was ₹750. A man bought the bed sheet for ₹560 after getting two successive discounts of which the first was 16%. How much was the second discount?

- A $11\frac{1}{2}\%$
- B $11\frac{1}{9}\%$
- C $11\frac{1}{4}\%$
- D $11\frac{4}{3}\%$

Answer: B

54. Find the value of $3 + \left\{ 1 + \frac{1}{3} - (3 - 4 \div 3) + \frac{1}{4} + \frac{2}{3} \right\}$

- A $\frac{7}{3}$
- B $\frac{11}{12}$
- C $\frac{43}{12}$
- D $\frac{4}{3}$

Answer: C

55. Kelvin and Kim can together finish a work in 25 days. They worked together for 15 days and then Kim left. After that, Kelvin finished the remaining work in 12 days. In how many days, can Kelvin alone finish the work?

- A 39
- B 34
- C 36
- D 30

Answer: D

56. The price of an article increases by 10% every year. If the difference between its price at the end of the first year and third year is ₹69.30, then its price (in ₹) at the end of fourth year will be:

- A 363.00
- B 441.93
- C 399.30
- D 439.23

Answer: D

57. A tradesman marks his goods 20% above the cost price and allows his customers 10% reduction on their bills. What percentage profit does he make?

- A 7%
- B 9%
- C 5%
- D 8%

Answer: D

58. A vendor bought 25 dozen fruits for ₹3,750. Out of these, 50 fruits were rotten and therefore thrown away. At what rate per dozen (in ₹) should he sell the remaining to gain 20% in the entire transaction?

- A 216
- B 180
- C 192
- D 204

Answer: A

59. The HCF of 552, 759 and 828 is x . The value of x lies between:

- A 65 and 70
- B 60 and 65
- C 55 and 60
- D 70 and 75

Answer: A

60. The average attendance at a cricket stadium increased by 15% in 2012 in comparison to the previous year. If 2160 more people came to see the matches in 2012, how many came in 2011?

- A 24000
- B 14400
- C 15000

D 32400

Answer: B

61. A sum of ₹7,560 is divided between A, B and C such that if their shares are diminished by ₹400, ₹300 and ₹260, respectively, then their shares are in the ratio 4 : 2 : 5. What is the original share (in ₹) of C?

A 2,800

B 1,500

C 3,260

D 6,600

Answer: C

62. The ratio of the present ages of A and B is 8 : 15. After four years from now, their ages will be in the ratio 9 : 16. What will be the sum of their ages (in years) after 8 years from now?

A 116

B 108

C 100

D 98

Answer: B

63. A shopkeeper marks his goods at 20% above the cost price and gives two successive discounts of 5% and 10%. The gain percentage is:

A 2.3%

B 3%

C 1.8%

D 2.6%

Answer: D

64. The area of a rectangular garden is $432m^2$. The perimeter (in m) of the rectangular garden whose length is 6 m more than its width is:

A 84

B 108

C 42

D 96

Answer: A

65. If A bought an item for ₹384 and sold for ₹527, and B bought another item for ₹1,264 and sold for ₹1,724, whose gain percentage is more and by how much approximately?

- A A by 1.63%
- B B by 1.54%
- C A by 0.84%
- D B by 0.65%

Answer: C

66. Sheena owned 4 plants on which fresh flowers come every 2nd, 3rd, 4th and 6th day. respectively. If on Tuesday, fresh flowers came on all the four plants, then on which day will fresh flowers come on all the four plants at the earliest?

- A Tuesday
- B Sunday
- C Monday
- D Thursday

Answer: B

67. A can complete a task in 15 days and B can do it in 20 days. What is their one day work together?

- A $\frac{8}{15}$
- B $\frac{7}{15}$
- C $\frac{7}{60}$
- D $\frac{9}{65}$

Answer: C

68. Anil started from city Y to city X at 4:20 am. He traveled at the speed of 70 km/h in the initial 1 hour 30 minutes. After that he reduced his speed by 50 km/h. If the distance between both the cities is 240 km, then at what time anil started?

- A 7.25 AM
- B 10.24 AM
- C 8.32 AM
- D 9.45 AM

Answer: C

69. The diameter of the base of a right circular cone is 60 cm and its height is 16 cm. The curved surface area (in cm^2) of the cone is:

- A 960π

- B 1020π
- C 1054π
- D 1088π

Answer: B

70. $3 \times 6 + 8 - 6 \div 3 + 9$ is equal to:

- A 12
- B 45
- C 21
- D 33

Answer: D

71. A man travels from A to B at a speed of 20 km/h and returns by increasing his speed by 50%. What is his average speed for both the trips?

- A 40 km/h
- B 48 km/h
- C 24 km/h
- D 36 km/h

Answer: C

72. Rs. 16,000 was lent for 2 years at the rate of 20% per annum compounded annually. If the interest was compounded half yearly instead of yearly, then interest will be Rs. 'x' more. What is the value of 'x'?

- A ₹378.20
- B ₹365.40
- C ₹372.80
- D ₹385.60

Answer: D

73. The monthly salaries of A, B and C are in the ratio 7 : 8 : 11. If the monthly salary of B is ₹3,600 less than that of C, then what is the annual salary (in ₹) of A?

- A 8,40,000
- B 1,00,800
- C 6,30,000

D 3,15,000

Answer: B

74. The simple interest on a certain sum of money for 2 years at 12% per annum is ₹60 less than the simple interest on the

A ₹1,400

B ₹900

C ₹1,200

D ₹1,000

Answer: D

75. If the compound interest on a certain sum for two years at 10% per annum compounded annually is ,360, then what is the sum?

A ₹16,500

B 16,000

C 15,000

D 15,5000

Answer: B

English

76. Select the most appropriate meaning of the given idiom.

Maiden speech

A Unprepared speech

B First speech

C Last speech

D Madam's speech

Answer: B

77. Select the most appropriate ANTONYM of the given word.

Dispute

A Trouble

B Confusion

C Doubt

D Agreement

Answer: D

78. The following sentence has been divided into parts. One of them may contain an error.

Select the part that contains the error from the given options. If you don't find any error, mark 'No error' as your answer.

By this time tomorrow / we will have / reached to Delhi.

- A we will have
- B No error
- C By this time tomorrow
- D reached to Delhi

Answer: D

79. Select the most appropriate meaning of the given idiom.

A dime a dozen

- A Something which can be bought only in dozens
- B Something which is not expensive
- C Something very common or of little value
- D Something which costs a dime

Answer: C

80. Select the most appropriate option to fill in the blank.

The situation became _____ after the scuffle between the farmers and the police.

- A sad
- B serious
- C funny
- D smooth

Answer: B

81. Select the most appropriate ANTONYM of the given word.

INVERT

- A Straighten
- B Reverse
- C Upset
- D Lean

Answer: A

82. Select the most appropriate option that can substitute the underlined segment in the given sentence. If there is no need to substitute it, select 'No substitution required'.

The farmer walked beside his bulls, isn't it?

- A didn't he
- B did he
- C No substitution required
- D didn't they

Answer: A

83. Select the most appropriate synonym of the given word.

Recover

- A Remain
- B Regain
- C Refrain
- D Retain

Answer: B

84. Select the most appropriate option to fill in the blank.

Mother's back was too _____ to work any longer, so she lay down to rest.

- A sick
- B sour
- C sore
- D soft

Answer: C

85. Select the INCORRECTLY spelt word.

- A Freeze
- B Freind
- C Frigid
- D Fright

Answer: A

86. Select the most appropriate option to fill in the blank.

War and Peace is a _____ written by Leo Tolstoy.

- A celebrated
- B notable

- C distinguished
- D masterpiece

Answer: D

87. The following sentence has been split into four segments. Identify the segment that contains a grammatical error.
The children were / bubbling with excitement / at the thought of / seeing sea.

- A bubbling with excitement
- B The children were
- C at the thought of
- D seeing sea

Answer: D

88. Select the most appropriate synonym of the given word.
Remedial

- A Superficial
- B Corrective
- C Harmful
- D Medicinal

Answer: B

89. Select the option that can be used as a one-word substitute for the given group of words.
An area where fruit trees are grown

- A Field
- B Orchard
- C Garden
- D Farm

Answer: B

90. Select the option that can be used as a one-word substitute for the given group of words.
A means of altering one's appearance to conceal one's identity

- A Distort
- B Disguise
- C Drape
- D Dress

Answer: B

91. Select the most appropriate option that can substitute the underlined segment in the given sentence. If there is no need to substitute it, select 'No substitution required'.

If we are not clear about the exact meaning of a word, we should look into a dictionary.

- A look on
- B look to
- C look of
- D look up

Answer: D

92. Select the INCORRECTLY spelt word.

- A Assistance
- B Exchanged
- C Curious
- D Participant

Answer: A

93. Select the most appropriate option that can substitute the underlined segment in the given sentence. If there is no need to substitute it, select 'No substitution required'.

Please don't confuse me by giving so many different directions.

- A by give so many
- B No substitution required
- C with giving so many
- D by giving so much

Answer: B

94. The following sentence has been split into four segments. Identify the segment that contains a grammatical error.
The penalty for / not wear masks / in public places / should be increased.

- A The penalty for
- B should be increased
- C in public places
- D not wear masks

Answer: D

95. Select the option that can be used as a one-word substitute for the given group of words.
To reduce to a shorter form intended to stand for the whole

- A Abbreviate
- B Shrink
- C Protract
- D Extend

Answer: A

Instructions [96 - 100]

In the following passage, some words have been deleted. Read the passage carefully and select the most appropriate option to fill in each blank.

Technology has made our lives simple and fast. The biggest (1)_____ has been the development of the internet. The internet is a (2)_____ of technology. It has brought us closer and people sitting at (3)_____ corners of the world can easily communicate. It facilitates shopping, money (4)_____, online earning etc. Cybercrimes are a result of the misuse of the internet. Children's (5)_____ to online games is another major problem faced by parents today.

96. **Select the most appropriate option to fill in blank no. a:**

- A supply
- B value
- C hindrance
- D contribution

Answer: D

97. **Select the most appropriate option to fill in blank no. b:**

- A favour
- B asset
- C boon
- D burden

Answer: C

98. **Select the most appropriate option to fill in blank no. c:**

- A distant
- B farther
- C further
- D near

Answer: A

99. **Select the most appropriate option to fill in blank no. 4.**

- A transactions
- B business
- C contracts
- D sites

Answer: A

100. Select the most appropriate option to fill in blank no. 5.

- A desire
- B interest
- C addiction
- D indifference

Answer: C

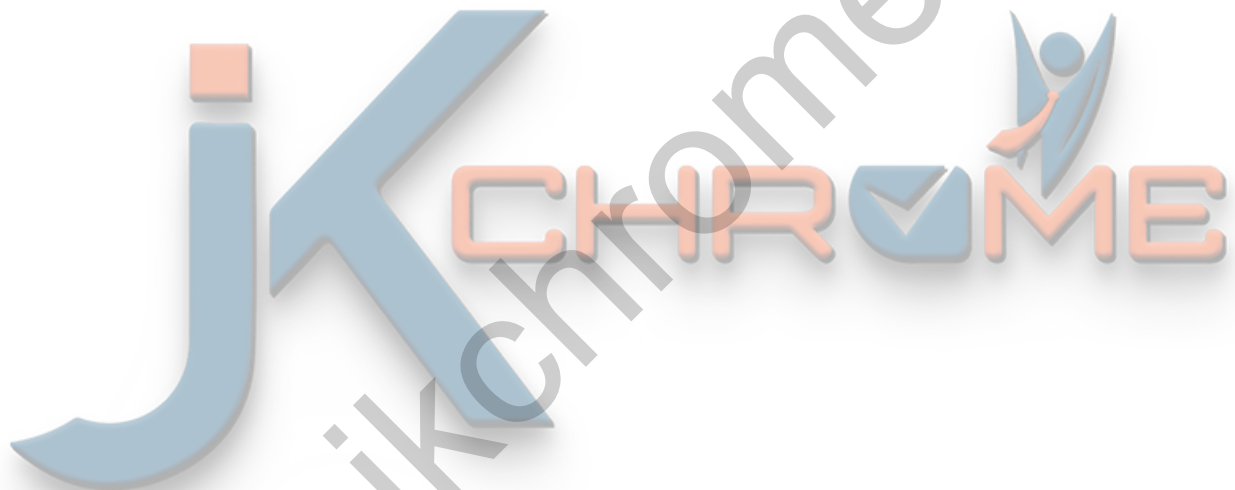



JK Chrome

JK Chrome | Employment Portal



Rated No.1 Job Application of India

Sarkari Naukri
Private Jobs
Employment News
Study Material
Notifications



JOBS



NOTIFICATIONS



G.K



STUDY MATERIAL

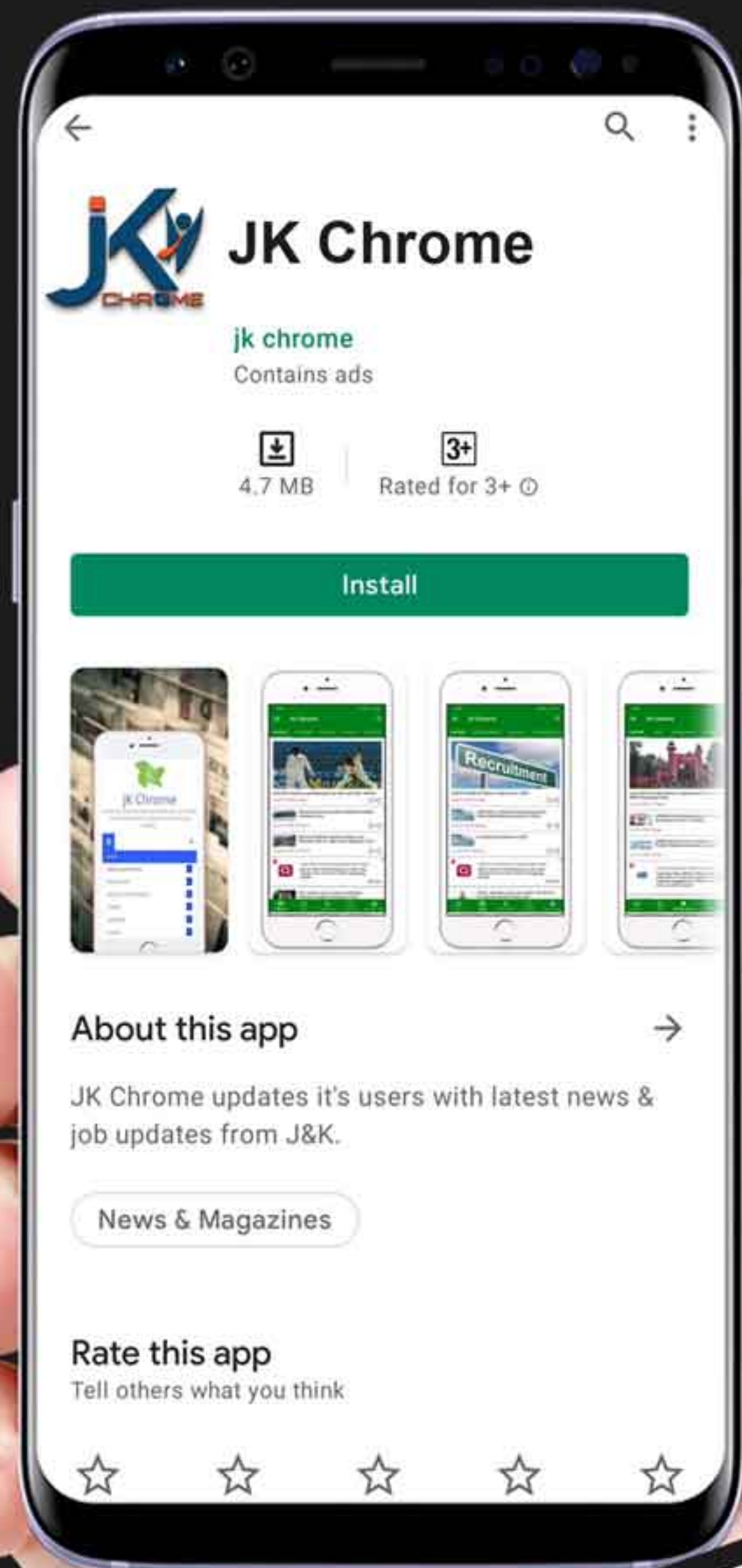

JK Chrome

jk chrome
Contains ads



www.jkchrome.com | Email : contact@jkchrome.com