



JK Chrome

JK Chrome | Employment Portal



Rated No.1 Job Application of India

Sarkari Naukri
Private Jobs
Employment News
Study Material
Notifications



JOBS



NOTIFICATIONS



G.K



STUDY MATERIAL



JK Chrome

jk chrome
Contains ads



www.jkchrome.com | Email : contact@jkchrome.com

SSC CGL

General Awareness

Instructions

For the following questions answer them individually

Question 1

Which of the following green house gases has the greatest heat-trapping ability?

- A Chlorofluoro carbon
- B Methane
- C Carbon dioxide
- D Nitrous oxide

Answer: A

Question 2

Which State of India is leading in solar energy generation ?

- A Gujarat
- B Rajasthan
- C Haryana
- D Uttar Pradesh

Answer: B

Question 3

Diamond does not conduct electricity, because

- A It's structure is very compact
- B It is of crystalline nature
- C There are only carbon atoms present in it
- D No free electrons are present in it

Answer: C

Question 4

Ganga is a result of confluence of rivers Bhagirathi and Alakananda at which place ?

- A Dev Prayag
- B Karan Prayag
- C Gangotri
- D Rudra Prayag

Answer: A

Question 5

What are Aldehydes ?

- A Mild oxidising agents
- B Strong oxidising agents
- C Strong reducing agents
- D Mild reducing agents

Answer: C

Question 6

Which circuit is used to store one bit of data ?

- A Register
- B Flip Flop
- C Vector
- D Encoder

Answer: B

Question 7

Why is weightlessness experienced while orbiting the earth in space ships ?

- A Inertia

- B Acceleration
- C Zero gravity
- D Orbital motion

Answer: C

Question 8

Which is the largest gland in human body?

- A Liver
- B Thyroid
- C Pituitary
- D Salivary gland

Answer: A

Question 9

Who was the President of Indian National Congress at the time of Indian independence ?

- A Maulana Abdul Kalam Azad
- B J. B. Kriplani
- C Jawahar Lal Nehru
- D Rajendra Prasad

Answer: B

Question 10

What is the minimum age for membership to Rajya Sabha ?

- A 20 years
- B 25 years
- C 30 years
- D 35 years

Answer: C

Question 11

What is an octroi ?

- A Tax
- B Tax collection centre
- C Tax processing centre
- D Tax information centre

Answer: A

Question 12

Sextant is an instrument used in which of the following ?

- A Gynaecology
- B Navigation
- C Birth control
- D Medical treatment

Answer: B

Question 13

Which of the following is not correctly matched?

- A The Mahakaal temple - Ujjain
- B Sringeri Matha - Chikkmanglur district
- C The Sun Temple - Konark
- D Jain temples - Khajuraho

Answer: D

Question 14**What is Gol Gumbadh ?**

- A Mausoleum of Hyder Ali
- B Mausoleum of Aurangazeb
- C Mausoleum of Chand Bibi
- D Mausoleum of Mohammed Adil Shah

Answer: D**Question 15****Where is a transistor most likely to be found ?**

- A Wrist watch
- B Fuse
- C Hearing aid
- D Fluorescent lamp

Answer: C**Question 16****Which organ of human body secretes Insulin?**

- A Pancreas
- B Kidney
- C Gall bladder
- D Liver

Answer: A**Question 17****If a healthy freshwater fish is placed in salt water, what will be the expected consequence ?**

- A The fish becomes dehydrated and dies

- B The fish becomes bloated and dies
- C The fish suffers from fungal or bacterial disease and dies
- D There is no observable effect on the fish provided there is sufficient food

Answer: A

Question 18

Which country is known as 'Land of Midnight Sun'?

- A Sweden
- B Norway
- C Germany
- D Finland

Answer: B

Question 19

Which river basin is shared by more than 10 States of India ?

- A Indus
- B Brahmaputra
- C Ganges
- D Damodar

Answer: C

Question 20

Who among the following was the first grammarian of the Sanskrit language?

- A Kalhana
- B Maitreyi
- C Kalidasa
- D Panini

Answer: D

Question 21

What is the total strength of the Rajya Sabha?

- A 250
- B 260
- C 270
- D 280

Answer: A

Question 22

Which of the following is done at a Stock Exchange ?

- A Commodities are bought and sold at wholesale price
- B Commodities are bought and sold at retail price
- C Securities are bought and sold
- D None of these

Answer: C

Question 23

Which of the following is India's military offensive against Pakistan in the Kargil war ?

- A Operation Kargil
- B Operation LOC
- C Operation Vijay
- D Operation Success

Answer: C

Question 24

Who gave the title 'Nightingale of India' to Sarojini Naidu ?

- A Jawaharlal Nehru
- B Rabindranath Tagore
- C Rajendra Prasad
- D Mahatma Gandhi

Answer: D

Question 25

The headquarters of RBI is in

- A Delhi
- B Kanpur
- C Mumbai
- D Nasik

Answer: C

Mathematics

Instructions

For the following questions answer them individually

Question 26

The value of $\sqrt{9 - 2\sqrt{16}} + 3\sqrt[3]{512}$ is

- A 6
- B 5
- C $2\sqrt{8}$
- D $3\sqrt{6}$

Answer: B

Explanation:

$$\begin{aligned}\text{Expression : } & \sqrt{9 - 2\sqrt{16}} + 3\sqrt[3]{512} \\ & = \sqrt{9 - (2 \times 4)} + (3 \times 8)\end{aligned}$$

$$= \sqrt{9 - 8 + 24} = \sqrt{25}$$

$$= 5$$

=> Ans - (B)

Question 27

The lengths of diagonals of a rhombus are 24cm and 10cm the perimeter of the rhombus (in cm) is :

A 52

B 56

C 68

D 72

Answer: A

Explanation:

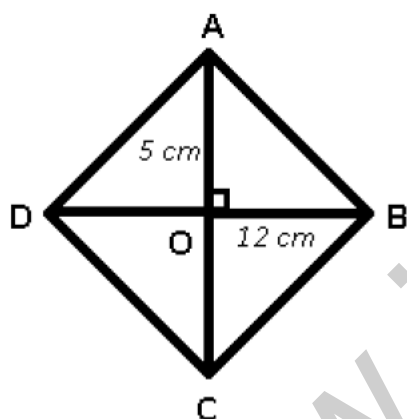

The diagonals of a rhombus bisect each other at right angle.

ABCD is the rhombus whose diagonals bisect at O.

Given : BD = 24 cm and AC = 10 cm

$$\Rightarrow OB = \frac{BD}{2} = 12 \text{ cm}$$

Similarly, OA = 5 cm

In $\triangle OAB$

$$\Rightarrow (AB)^2 = (OA)^2 + (OB)^2$$

$$\Rightarrow (AB)^2 = (5)^2 + (12)^2$$

$$\Rightarrow (AB)^2 = 25 + 144 = 169$$

$$\Rightarrow AB = \sqrt{169} = 13 \text{ cm}$$

\therefore Perimeter of rhombus = $4 \times AB$ [\because All sides of rhombus are equal]

$$= 4 \times 13 = 52 \text{ cm}$$

=> Ans - (A)

Question 28

A dishonest shopkeeper professes to sell goods at his cost price but uses a false weight of 950 gms, for each kilogram. His gain percentage is

A $6\frac{1}{4}\%$

B $5\frac{5}{19}\%$

C $5\frac{3}{17}\%$

D $6\frac{2}{7}\%$

Answer: B

Explanation:

Let the cost price of the shopkeeper = Rs. 1000/kg

=> He buys 1 gm for Rs. 1

Since, he uses false weight of 950 gms, selling price = Rs. 1000/950 gm

$$\Rightarrow \text{He sells 1 gm for} = \frac{1000}{950} = \text{Rs. } \frac{20}{19}$$

$$\therefore \text{Profit \%} = \frac{SP-CP}{CP} \times 100$$

$$= \frac{\frac{20}{19}-1}{1} \times 100$$

$$= \frac{100}{19} = 5\frac{5}{19}\%$$

=> Ans - (B)

Question 29

Ratio of A's age to B's age is 4:3. 'A' will be 26 years old after 6 years. The age of B now is

A $19\frac{1}{2}$

B 12 years

C 21 years

D 15 years

Answer: D

Explanation:

It is given that A will be 26 years old after 6 years

$$\Rightarrow \text{A's present age} = 26 - 6 = 20 \text{ years}$$

$$\text{Also, ratio of A : B present ages} = 4 : 3$$

$$\Rightarrow \text{B's present age} = \frac{3}{4} \times 20$$

$$= 3 \times 5 = 15 \text{ years}$$

\Rightarrow Ans - (D)

Question 30

If the Arithmetic mean of 7, 5, 13, x and 9 is 10, then the value of x is

A 10

B 12

C 14

D 16

Answer: D

Explanation:

Arithmetic mean of 7, 5, 13, x and 9 = 10

$$\Rightarrow \frac{(7+5+13+x+9)}{5} = 10$$

$$\Rightarrow 34 + x = 10 \times 5 = 50$$

$$\Rightarrow x = 50 - 34 = 16$$

\Rightarrow Ans - (D)

Question 31

A man sells an article at 15% profit. If he had sold it for ₹ 6 more, he would have gained 18%. The man bought the article for

A 100

B 150

C 200

D 250

Answer: C

Explanation:

Let cost price of the article = Rs. $100x$

Profit % = 15%

$$\Rightarrow \text{Selling price} = 100x \times \frac{115}{100} = \text{Rs. } 115x$$

Now, if $SP = (115x + 6)$, then

$$\text{Profit \%} = \frac{(115x+6)-100x}{100x} \times 100 = 18$$

$$\Rightarrow \frac{15x+6}{x} = 18$$

$$\Rightarrow 15x + 6 = 18x$$

$$\Rightarrow 18x - 15x = 3x = 6$$

$$\Rightarrow x = \frac{6}{3} = 2$$

\therefore Cost price = $100 \times 2 = Rs.200$

\Rightarrow Ans - (C)

Question 32

A's salary was decreased by 50% and subsequently increased by 50%. How much percent does he lose?

A 25%

B 50%

C $12\frac{1}{2}\%$

D No loss

Answer: A

Explanation:

Let A's initial salary = $Rs.100x$

First it was decreased by 50%, \Rightarrow A's salary = $100x - \frac{50}{100} \times 100x = Rs.50x$

Then it was increased by 50%, \Rightarrow A's salary = $50x + \frac{50}{100} \times 50x = Rs.75x$

\therefore Percent of salary that he lost = $\frac{100x-75x}{100x} \times 100$

= 25%

\Rightarrow Ans - (A)

Question 33

A car moving in the morning fog passes a man walking at 4km/h. in the same direction. The man can see the car for 3 minutes and visibility is upto a distance of 130m. The speed of the car is :

A $7\frac{3}{5}$

B $6\frac{3}{5}$

C 7km/h.

D 5km/h.

Answer: B

Explanation:

Let the speed of car = s km/hr and speed of man = 4 km/hr

Since, they both are moving in same direction, thus relative speed = $(s - 4)$ km/hr

Visibility of the car = 130 m for 3 minutes

$$\Rightarrow \text{speed} = \frac{130}{3} \text{ m/min}$$

$$= \left(\frac{130}{3} \times \frac{60}{1000} \right) \text{ km/hr} = \frac{13}{5} \text{ km/hr}$$

$$\text{According to ques, } \Rightarrow (s - 4) = \frac{13}{5}$$

$$\Rightarrow s = \frac{13}{5} + 4$$

$$\Rightarrow s = \frac{33}{5} = 6\frac{3}{5} \text{ km/hr}$$

\Rightarrow Ans - (B)

Question 34

A money lender lends Rs. 400 for 3 years to a person and lends Rs. 500 for 4 years to the other person at the same rate of simple interest. If altogether he receives Rs. 160 as interest, what is the rate of interest per annum ?

A 5%

B 7%

C 9%

D 10%

Answer: A

Explanation:

Let the rate of interest = $r\%$

For the first person, Principal (P_1) = Rs.400 and time (T_1) = 3 years

For the second person, Principal (P_2) = Rs.500 and time (T_2) = 4 years

Total interest earned under simple interest = Rs. 160

$$\Rightarrow \left(\frac{P_1 \times r \times T_1}{100} \right) + \left(\frac{P_2 \times r \times T_2}{100} \right) = 160$$

$$\Rightarrow \left(\frac{400 \times r \times 3}{100} \right) + \left(\frac{500 \times r \times 4}{100} \right) = 160$$

$$\Rightarrow 12r + 20r = 160$$

$$\Rightarrow 32r = 160$$

$$\Rightarrow r = \frac{160}{32} = 5\%$$

\Rightarrow Ans - (A)

Question 35

If $x = 1/(\sqrt{2}+1)$ then the value of $x^2 + 2x - 1$ is

- A $2\sqrt{2}$
- B 4
- C 0
- D 2

Answer: C

Explanation:

$$\text{Expression : } x = \frac{1}{\sqrt{2}+1}$$

$$\Rightarrow x = \frac{1}{\sqrt{2}+1} \times \frac{\sqrt{2}-1}{\sqrt{2}-1}$$

$$\Rightarrow x = \frac{\sqrt{2}-1}{(\sqrt{2})^2-(1)^2} = \frac{\sqrt{2}-1}{2-1}$$

$$\Rightarrow x = \sqrt{2} - 1$$

To find : $x^2 + 2x - 1$

$$= (\sqrt{2} - 1)^2 + 2(\sqrt{2} - 1) - 1$$

$$= (2 + 1 - 2\sqrt{2}) + (2\sqrt{2} - 2) - 1$$

$$= 3 - 3 = 0$$

\Rightarrow Ans - (C)

Question 36

If $x + 1/x = \sqrt{13}$, then $3x/(x^2-1)$ equal to

- A $3\sqrt{13}$
- B $\sqrt{13}/3$
- C 1
- D 3

Answer: C

Explanation:

$$\text{Given : } x + \frac{1}{x} = \sqrt{13}$$

Squaring both sides

$$\Rightarrow \left(x + \frac{1}{x}\right)^2 = (\sqrt{13})^2$$

$$\Rightarrow x^2 + \frac{1}{x^2} + \left(2 \cdot x \cdot \frac{1}{x}\right) = 13$$

$$\Rightarrow x^2 + \frac{1}{x^2} = 13 - 2 = 11 \text{ -----(i)}$$

$$\text{Also, we know that : } \left(x - \frac{1}{x}\right)^2 = x^2 + \frac{1}{x^2} - \left(2 \cdot x \cdot \frac{1}{x}\right)$$

Substituting value from equation (i)

$$\Rightarrow \left(x - \frac{1}{x}\right)^2 = 11 - 2 = 9$$

$$\Rightarrow \left(x - \frac{1}{x}\right) = \sqrt{9} = 3$$

$$\Rightarrow x^2 - 1 = 3x$$

$$\Rightarrow \frac{3x}{x^2 - 1} = 1$$

\Rightarrow Ans - (C)

Question 37

O is an centre of a circle. P is an external point of it at distance of 13cm from O. The radius of the circle is 5cm. Then the length of a tangent to the circle from P upto the point of contact is

A $\sqrt{194}$ cm

B 10cm

C 12cm

D 8cm

Answer: C

Explanation:

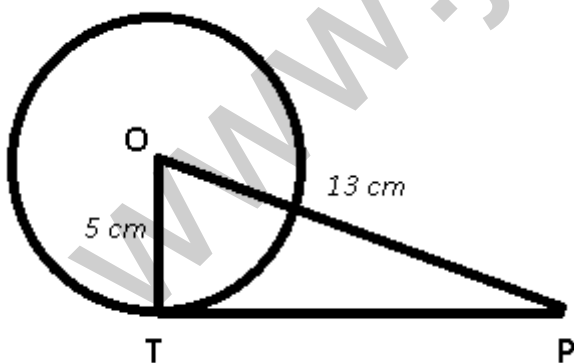

Given : OT is radius of circle = 5 cm and OP = 13 cm

To find : Tangent PT = ?

Solution : The radius of a circle intersects the tangent at right angle, $\Rightarrow \angle OTP = 90^\circ$

Thus in $\triangle OPT$,

$$\Rightarrow (PT)^2 = (OP)^2 - (OT)^2$$

$$\Rightarrow (PT)^2 = (13)^2 - (5)^2$$

$$\Rightarrow (PT)^2 = 169 - 25 = 144$$

$$\Rightarrow PT = \sqrt{144} = 12 \text{ cm}$$

\Rightarrow Ans - (C)

Question 38

If θ is acute angle and $\sin(\theta+18^\circ) = 1/2$, then the value of θ in circular measure is

- A $\pi/12$ radians
- B $\pi/15$ radians
- C $2\pi/5$ radians
- D $3\pi/13$ radians

Answer: B

Explanation:

Given : $\sin(\theta + 18^\circ) = \frac{1}{2}$

$$\Rightarrow \sin(\theta + 18^\circ) = \sin(30^\circ)$$

$$\Rightarrow \theta + 18^\circ = 30^\circ$$

$$\Rightarrow \theta = 30^\circ - 18^\circ = 12^\circ$$

Now, $180^\circ = \pi$ radians

$$\Rightarrow 12^\circ = \frac{\pi}{180} \times 12 = \frac{\pi}{15} \text{ radians}$$

\Rightarrow Ans - (B)

Question 39

18 men or 36 boys working 6 hours a day can plough a field in 24 days. In how many days will 24 men and 24 boys working 9 hours a day plough the same field ?

- A 9
- B 10
- C 6
- D 8

Answer: D

Explanation:

18 men 6 hrs a day take 24 days

$$\text{Time taken by 1 man in 1 hour} = \frac{1}{18} \times \frac{1}{6} \times \frac{1}{24} = \frac{1}{2592}$$

36 boys 6 hours take 24 days

$$\text{Time taken by 1 boy in 1 hour} = \frac{1}{18} \times \frac{1}{6} \times \frac{1}{24} = \frac{1}{2592}$$

$$\Rightarrow 24 \text{ men } 9 \text{ hours/day will cover} = 24 \times 9 \times \frac{1}{2592} = \frac{216}{2592} \text{ of the field}$$

$$\text{and } 24 \text{ boys } 9 \text{ hours/day will cover} = 24 \times 9 \times \frac{1}{5184} = \frac{216}{5184} \text{ of the field}$$

Thus, the size of field covered in 1 day by the 24 men and the 24 boys

$$= \frac{216}{2592} + \frac{216}{5184} = \frac{(432+216)}{5184}$$

$$= \frac{648}{5184} = \frac{1}{8}$$

\therefore Required time taken = 8 days

\Rightarrow Ans - (D)

Question 40

If $a(x + y) = b(x - y) = 2ab$, then the value of $2(x^2 + y^2)$ is

A $2(a^2 - b^2)$

B $2(a^2 + b^2)$

C $4(a^2 - b^2)$

D $4(a^2 + b^2)$

Answer: D

Explanation:

Given : $a(x + y) = b(x - y) = 2ab$

$$\Rightarrow a(x + y) = 2ab$$

$$\Rightarrow (x + y) = 2b$$

Squaring both sides,

$$\Rightarrow (x + y)^2 = (2b)^2$$

$$\Rightarrow x^2 + y^2 + 2xy = 4b^2 \text{ -----(i)}$$

Similarly, $(x - y) = 2a$

Squaring both sides,

$$\Rightarrow (x - y)^2 = (2a)^2$$

$$\Rightarrow x^2 + y^2 - 2xy = 4a^2 \text{ -----(ii)}$$

Adding equations (i) and (ii), we get :

$$\Rightarrow 2x^2 + 2y^2 = 4a^2 + 4b^2$$

$$\Rightarrow 2(x^2 + y^2) = 4(a^2 + b^2)$$

=> Ans - (D)

Question 41

If $x + 1/x = 6$, then value of $x^2 + 1/x^2$ is

A 23

B 16

C 34

D 32

Answer: C

Explanation:

Given : $x + \frac{1}{x} = 6$

Squaring both sides

$$= \left(x + \frac{1}{x}\right)^2 = (6)^2$$

$$= (x)^2 + \left(\frac{1}{x}\right)^2 + \left(2 \cdot x \cdot \frac{1}{x}\right) = 36$$

$$\Rightarrow x^2 + \frac{1}{x^2} = 36 - 2 = 34$$

=> Ans - (C)

Question 42

G is the centroid of the equilateral triangle ABC, if AB = 9cm then AG is equal to

A $3\sqrt{3}$ cm

B 3cm

C $3\sqrt{3}/2$ cm

D 6cm

Answer: A

Explanation:

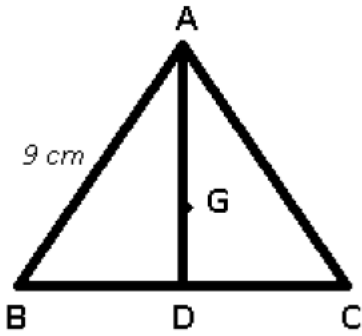

Side of equilateral triangle (a) = 9 cm

Median AD of equilateral triangle = $\frac{\sqrt{3}a}{2}$

$$\Rightarrow AD = \frac{9\sqrt{3}}{2}$$

Also, a centroid divides the median in the ratio 2 : 1

$$\Rightarrow AG : GD = 2 : 1$$

$$\therefore AG = \frac{2}{3} \times AD$$

$$= \frac{2}{3} \times \frac{9\sqrt{3}}{2} = 3\sqrt{3} \text{ cm}$$

\Rightarrow Ans - (A)

Question 43

In the figure (not drawn to scale) given below, if $AD = DC = BC$ and $\angle BCE = 96^\circ$, then $\angle DBC$ is

- A 32°
- B 84°
- C 64°
- D 96°

Answer: C

Question 44

If θ is positive acute angle and $4\sin^2\theta = 3$, then the value of $\tan\theta - \cot\theta/2$ is

- A 1
- B 0
- C $\sqrt{3}$
- D $1/\sqrt{3}$

Answer: B

Explanation:

$$\text{Given : } 4\sin^2\theta = 3$$

$$\Rightarrow \sin^2\theta = \frac{3}{4}$$

$$\Rightarrow \sin\theta = \sqrt{\frac{3}{4}} = \frac{\sqrt{3}}{2}$$

$$\Rightarrow \sin\theta = \sin(60^\circ)$$

$$\Rightarrow \theta = 60^\circ$$

To find : $\tan\theta - \cot\theta/2$

$$= \tan(60^\circ) - \cot(30^\circ)$$

$$= \sqrt{3} - \sqrt{3} = 0$$

\Rightarrow Ans - (B)

Question 45

The chord AB of a circle of centre O subtends an angle θ with the tangent at A to the circle. Then measure of $\angle ABO$ is

- A θ
- B $90^\circ - \theta$
- C $90^\circ + \theta$
- D $2(180^\circ - \theta)$

Answer: B

Explanation:

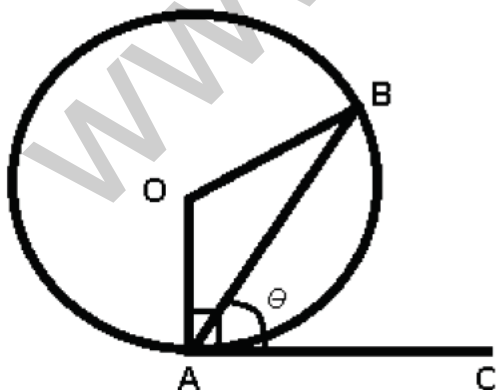

$$\text{Given : } \angle BAC = \theta$$

To find : $\angle ABO = ?$

Solution : AC is the tangent of the circle, $\Rightarrow \angle OAC = 90^\circ$

$$\Rightarrow \angle OAB = 90^\circ - \theta$$

Also, $OA = OB =$ radii of circle

$$\Rightarrow \angle OBA = \angle OAB = 90^\circ - \theta$$

\Rightarrow Ans - (B)

Question 46

From a point on a bridge across the river, the angles of depression of the banks on opposite sides of the river are 30° and 45° respectively. If the bridge is at a height of 2.5m from the banks, then the width of the river is (take $\sqrt{3} = 1.732$)

A 5.83m

B 6.83m

C 5.76m

D 6.87m

Answer: B

Explanation:

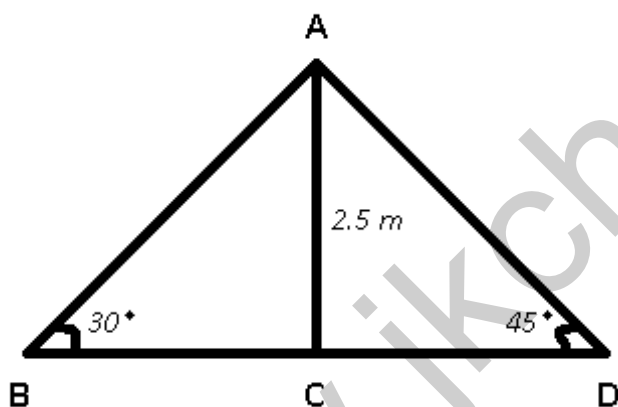

AC is the height of the bridge = 2.5 m

Width of river = $BD = ?$

In $\triangle ACD$,

$$\Rightarrow \tan(\angle ACD) = \frac{AC}{CD}$$

$$\Rightarrow \tan(45^\circ) = 1 = \frac{2.5}{CD}$$

$$\Rightarrow CD = 2.5 \text{ m}$$

Similarly, in $\triangle ABC$,

$$\Rightarrow \tan(30^\circ) = \frac{2.5}{BC}$$

$$\Rightarrow \frac{1}{\sqrt{3}} = \frac{2.5}{BC}$$

$$\Rightarrow BC = 2.5 \times 1.732 = 4.33 \text{ m}$$

$$\therefore BD = BC + CD$$

$$= 2.5 + 4.33 = 6.83 \text{ m}$$

=> Ans - (B)

Instructions

The pie-chart given below show usage of materials in a construction of a house. Study the chart and answers the questions :

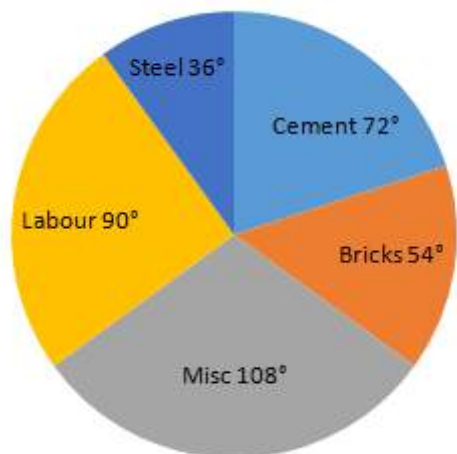

Question 47

The percentage of steel used in the construction of a house

- A 10%
- B 12%
- C 20%
- D 36%

Answer: A

Explanation:

Usage of steel = 36°

=> Percentage of steel used in the construction of a house = $\frac{36^\circ}{360^\circ} \times 100$

= $\frac{100}{10} = 10\%$

=> Ans - (A)

Question 48

The ratio of cement and bricks used in the construction is

- A 3:4

B 2:3

C 4:3

D 2:5

Answer: C

Explanation:

Usage of cement = 72°

Usage of bricks = 54°

=> Required ratio = $\frac{72}{54} = \frac{4}{3}$

=> Ans - (C)

Question 49

If the cost of cement is ₹ 5000/- then the labour cost is

A 5500

B 6250

C 9000

D 4000

Answer: B

Explanation:

Let cement used = Rs. $72x$

According to ques, => $72x = 5000$

Multiplying both sides by $\frac{5}{4}$

=> $72x \times \frac{5}{4} = 5000 \times \frac{5}{4}$

=> Labour cost = $90x = 1250 \times 5 = \text{Rs. } 6250$

=> Ans - (B)

Question 50

The average of percentages of steel, cement and miscellaneous items used in the construction is

A 10%

B 25%

C 20%

D 35%

Answer: C

Explanation:

Usage of steel, cement and miscellaneous items in the construction

$$= 36^\circ + 72^\circ + 108^\circ = 216^\circ$$

$$\text{Average usage of the three} = \frac{216^\circ}{3} = 72^\circ$$

∴ Average of percentages of steel, cement and miscellaneous items used in the construction

$$= \frac{72}{360} \times 100 = \frac{100}{5} = 20\%$$

=> Ans - (C)

English

Instructions

For the following questions answer them individually

Question 51

In the following question, out of the four alternatives, choose the word which best expresses the meaning of the given word and click the button corresponding to it.

REPROOF

- A WARNING
- B RIDICULE
- C REBUKE
- D THREAT

Answer: C

Question 52

In the following question, out of the four alternatives, choose the word which is opposite in meaning to the given word and click the button corresponding to it.

- A PRICELESS
- B RARE
- C INESTIMABLE

D WORTHLESS

Answer: D

Question 53

Four words are given, out of which only one word is spelt correctly. Choose the correctly spelt word and click the button corresponding to it.

A Stagnation

B Stagnation

C Stagnation

D Stegnation

Answer: C

Question 54

In the following questions, one part of the sentence may have an error. Find out which part of the sentence has an error and click the button corresponding to it. If the sentence is free from error, click the "No error" option.

I have come (A)/ as soon as (B)/ the customers leave your shop (C)/ No Error (D)

A A

B B

C C

D D

Answer: A

Question 55

In the following questions, one part of the sentence may have an error. Find out which part of the sentence has an error and click the button corresponding to it. If the sentence is free from error, click the "No error" option.

I called (A)/ at his house yesterday (B)/ and have given him money (C)/ No Error (D)

A A

B B

C C

D D

Answer: C

Question 56

In the following questions, one part of the sentence may have an error. Find out which part of the sentence has an error and click the button corresponding to it. If the sentence is free from error, click the "No error" option.

The reason for (A)/ my absence is (B)/ due to ill health (C)/ No Error (D)

A A

B B

C C

D D

Answer: C

Question 57

The sentences given with blanks are to be filled with an appropriate word(s). Four alternatives are suggested for each question. For each question, choose the correct alternative and click the button corresponding to it.

I like _____ in the sun.

A laying

B lay

C lie

D lying

Answer: D

Question 58

The sentences given with blanks are to be filled with an appropriate word(s). Four alternatives are suggested for each question. For each question, choose the correct alternative and click the button corresponding to it.

Please do not _____ an offer made by the Chairman.

A deny

B refuse

C refrain

D refuge

Answer: B

Question 59

The sentences given with blanks are to be filled with an appropriate word(s). Four alternatives are suggested for each question. For each question, choose the correct alternative and click the button corresponding to it.

The clerk asked for my _____.

A determination

B destiny

C destination

D designation

Answer: D

Question 60

In each of the questions, four alternatives are given for the Idiom/Phrase. Choose the alternative which best expresses the meaning of the Idiom/Phrase and click the button corresponding to it.

Evening of life

A Old age

B A party

C Holiday

D None of these

Answer: A

Question 61

In each of the questions, four alternatives are given for the Idiom/Phrase. Choose the alternative which best expresses the meaning of the Idiom/Phrase and click the button corresponding to it.

Button her lip

A Tell us more

B Stop talking

- C Invite us too
- D Enjoy herself

Answer: B

Question 62

In each of the questions, four alternatives are given for the Idiom/Phrase. Choose the alternative which best expresses the meaning of the Idiom/Phrase and click the button corresponding to it.

Invent cock and bull stories

- A Delightful fables
- B Eco-friendly accounts
- C Absurd and unlikely stories
- D Credible tales

Answer: C

Question 63

Out of the four alternatives, choose the one which can be substituted for the given words/sentences and click the button corresponding to it.

Act of making things like new again.

- A Innovate
- B Renovate
- C Motivate
- D Activate

Answer: B

Question 64

Out of the four alternatives, choose the one which can be substituted for the given words/sentences and click the button corresponding to it.

One who knows everything.

- A Omniscient
- B Conscious

C Intellectual

D Learned

Answer: A

Question 65

Out of the four alternatives, choose the one which can be substituted for the given words/sentences and click the button corresponding to it.

Any morbid dread of water.

A Hydrofoil

B Hydrophobia

C Hydraulic

D Hyacinth

Answer: B

Question 66

A sentence/a part of the sentence is underlined. Four alternatives are given to the underlined part which will improve the sentence. Choose the correct alternative and click the button corresponding to it. In case no improvement is needed, click the button corresponding to "No improvement".

You have come here with the intention in insulting me.

A for insulting me

B of insulting me

C on insulting me

D No improvement

Answer: B

Explanation:

"of insulting me" because it is correct phrase. preposition 'of' is appropriate in the given context of the sentence. Hence the answer is B

Question 67

A sentence/a part of the sentence is underlined. Four alternatives are given to the underlined part which will improve the sentence. Choose the correct alternative and click the button corresponding to it. In case no improvement is needed, click the button corresponding to "No improvement".

I did not give at the examination as my circumstances are bad.

- A write
- B sit
- C appear
- D No improvement

Answer: C

Explanation:

"Give" is actually making the sentence structurally incorrect.

We use "appear" in the context of the exam. Other options are irrelevant.

Hence answer is C

Question 68

A sentence/a part of the sentence is underlined. Four alternatives are given to the underlined part which will improve the sentence. Choose the correct alternative and click the button corresponding to it. In case no improvement is needed, click the button corresponding to "No improvement".

Though he worked hard, but he failed.

- A and
- B yet
- C then
- D No improvement

Answer: B

Explanation:

Use of "but" here is wrong cause Though is followed by 'yet'. When *though / although / even though* is used with a verb, which is in the subjunctive mood, mainly expressing doubt, a condition contrary to a fact, a wish, or a concession, it should be followed by *yet*. *Yet* actually means *still*.

Hence B

Question 69

A sentence/a part of the sentence is underlined. Four alternatives are given to the underlined part which will improve the sentence. Choose the correct alternative and click the button corresponding to it. In case no improvement is needed, click the button corresponding to "No improvement".

No sooner did the teacher come into the class when we stood up.

- A since
- B then
- C than
- D No improvement

Answer: C

Explanation:

The combination of "did" with the "bare infinitive" is sometimes called an "emphatic" tense, and so the first sentence might be more "emphatic," calling attention to the fact that the teacher really entered the room.

The expression '**no sooner...than**' is used to suggest that one action or situation takes place/took place immediately after another action or situation.

When '**no sooner**' goes at the beginning of the sentence, we use an inverted word order. That means the auxiliary verb goes before the subject.

Hence option C

Question 70

A sentence/a part of the sentence is underlined. Four alternatives are given to the underlined part which will improve the sentence. Choose the correct alternative and click the button corresponding to it. In case no improvement is needed, click the button corresponding to "No improvement".

He was so much a coward to help his friend.

- A so much cowardly
- B too much of a coward
- C as coward
- D No improvement

Answer: B

Explanation:

The phrase " so much " in connection to the extent of cowardice is unwarranted.

" too much of a coward " is the correct connotation and hence the answer is B

Instructions

A passage is given with 5 questions following it. Read the passage carefully and choose the best answer to each question out of the four alternatives and click the button corresponding to it. In the world today we make health an end in itself. We have forgotten that health really means to enable a person to do his work and do it well. A lot of modern medicine, and this includes many patients as well as many physicians, pay very little attention to health but very much attention to those who imagine they are ill. Our great concern with health is shown by the medical columns in newspapers, the health articles in popular magazines and the popularity of television programmes and all those books on medicine. We talk about health all the time. Yet for the most part the only result is more people with imaginary illness. A healthy man should not be wasting time talking about health : he should be using health for work.

Question 71

Modern medicine is primarily concerned with

- A promotion of good health
- B people suffering from imaginary illness
- C people suffering from real illness
- D increased efficiency in work

Answer: B

Question 72

The passage suggests that

- A health is an end in itself
- B health is a blessing
- C health is only a means to an end
- D we should not talk about health

Answer: C

Question 73

Talking about health all the time makes people

- A always suffer from imaginary illness
- B sometimes suffer from imaginary illness

- C rarely suffer from imaginary illness
- D often suffer from imaginary illness

Answer: D

Question 74

The passage tells us

- A how medicine should be manufactured
- B what a healthy man should or should not do
- C what television programmes should be about
- D how best to imagine illness

Answer: B

Question 75

A healthy man should be concerned with

- A his work which good health makes possible
- B looking after his health
- C his health which makes work possible
- D talking about health

Answer: A

Reasoning

Instructions

For the following questions answer them individually

Question 76

Select the related word/letters/numbers from the given alternatives:

Air:Bird::Water: ?

- A Fish
- B Swim

C Wash

D Drink

Answer: A

Explanation:

Bird flies in the air, and fish swims in the water.

=> Ans - (A)

Question 77

Select the related word/letters/numbers from the given alternatives:

ACEG:BDFH::IKMO: ?

A IJKL

B JLNP

C KLMN

D HIJK

Answer: B

Explanation:

Expression = ACEG:BDFH::IKMO: ?

The pattern followed is =

A	C	E	G
(+1)	(+1)	(+1)	(+1)
B	D	F	H

Similarly, for IKMO :

I	K	M	O
(+1)	(+1)	(+1)	(+1)
J	L	N	P

=> Ans - (B)

Question 78

Select the related word/letters/numbers from the given alternatives:

12:20::30: ?

A 15

B 35

C 42

D 48

Answer: C

Explanation:

Expression = 12:20::30: ?

The pattern followed is =

$$3 \times 4 = 12$$

$$4 \times 5 = 20$$

$$5 \times 6 = 30$$

$$6 \times 7 = 42$$

=> Ans - (C)

Question 79

For the following questions

Find the odd word/letters/number pair from the given alternatives.

(A) Neurologist (B) Dentist (C) Architect (D) Pediatrician

A A

B B

C C

D D

Answer: C

Explanation:

Neurologist, Dentist and Pediatrician are related to medical science, hence architect who is related to engineering is the odd one out.

=> Ans - (C)

Question 80

For the following questions

Find the odd word/letters/number pair from the given alternatives.

A A

B B

C C

D D

Answer: A

Explanation:

Among the given alphabets, only A is a vowel hence it is the odd one.

=> Ans - (A)

Question 81

For the following questions

Find the odd word/letters/number pair from the given alternatives.

A A

B B

C C

D D

Answer: A

Explanation:

A is a vowel, rest all are consonants.

=> Ans - (A)

Question 82

Arrange the following words as per order in the dictionary.

1. Syringe
2. Syphilis
3. Syncretism
4. Synarchy
5. Submerge

A 4,5,2,3,1

B 5,4,3,2,1

C 5,3,4,1,2

D 4,1,2,3,5

Answer: B

Explanation:

As per the dictionary,

= Submerge -> Synarchy -> Syncretism -> Syphilis -> Syringe

≡ 5,4,3,2,1

=> Ans - (B)

Question 83

A series is given, with one term missing. Choose the correct alternative from the given ones that will complete the series.

WYV, ?, IKH, BDA

A OPR

B ROP

C PRO

D OQH

Answer: C

Explanation:

Expression : WYV, ?, IKH, BDA

The pattern followed is that there is a gap of six letters between each letters in every term.

1st letter : W (-7 letters) = P (-7 letters) = I (-7 letters) = B

2nd letter : Y (-7 letters) = R (-7 letters) = K (-7 letters) = D

3rd letter : V (-7 letters) = O (-7 letters) = H (-7 letters) = A

Thus, missing term = **PRO**

=> Ans - (C)

Question 84

Which number will complete the series?

6, 8, 17, 19, 28, 30, ?

A 32

B 37

C 38

D 39

Answer: D

Explanation:

The numbers '2' and '9' are alternatively added.

$$6 + 2 = 8$$

$$8 + 9 = 17$$

$$17 + 2 = 19$$

$$19 + 9 = 28$$

$$28 + 2 = 30$$

$$30 + 9 = \mathbf{39}$$

=> Ans - (D)

Question 85

A is B's brother, C is A's mother, D is C's father, F is A's son. How is A related to F's child?

- A Aunt
- B Cousin
- C Nephew
- D Grandfather

Answer: D

Explanation:

Note :- The first three statements are redundant.

From the last statement, F is the son of A.

Thus, F's child is the grandchild of A.

=> A is the grandfather of F's child

=> Ans - (D)

Question 86

Seven boys A,B,C,D,E,F and G are standing in a line.

- (i) G is between A and E
- (ii) F and A have one boy between them
- (iii) E and C have two boys between them
- (iv) D is immediate right of F
- (v) C and B have three boys between them

Who is second from left?

- A C

B G

C E

D A

Answer: C

Explanation:

G is between A and E, => Let us take E to the left of G and A to the right of G.

F and A have one boy between them, => F is second to the right of A (∵ E is second to the left).

E and C have two boys between them, => C is between A and F (∵ there are only 7 boys).

D is immediate right of F and C and B have three boys between them, => B is to the extreme left.

∴ Arrangement = **B E G A C F D**

Thus, E is second from the left.

=> Ans - (C)

Question 87

From the given alternative words, select the word which cannot be formed using the letters of the given word:

MEASUREMENT

A TEAMS

B MASTER

C SUMMIT

D SUMMER

Answer: C

Explanation:

The word MEASUREMENT does not contain any 'I', and thus the word 'Summit' cannot be formed.

=> Ans - (C)

Question 88

In a certain code language the word EXAMPLES is written as EMAXSEPL. How will the word BUOYANCY be written in that language?

A YBANCYOU

B CUOYYBAN

C CUYOYBAN

D CYOUYBAN

Answer: D

Explanation:

EXAMPLES is written as EMAXSEPL

The pattern followed is :

1	2	3	4	5	6	7	8
E	X	A	M	P	L	E	S
E	M	A	X	S	E	P	L
7	4	3	2	8	1	5	6

Similarly, for BUOYANCY :

1	2	3	4	5	6	7	8
B	U	O	Y	A	N	C	Y
C	Y	O	U	Y	B	A	N
7	4	3	2	8	1	5	6

=> Ans - (D)

Question 89

If P denotes multiply, T denotes subtraction, M denotes addition, B denotes division then $28B7P8T6M4 = ?$

A 28

B 30

C 32

D 34

Answer: B

Explanation:

Expression : $28B7P8T6M4 = ?$

$$\equiv 28 \div 7 \times 8 - 6 + 4$$

$$= 4 \times 8 - 2$$

$$= 32 - 2 = 30$$

=> Ans - (B)

Question 90

In this question, some equations are solved on the basis of a certain system. On the same basis find out the correct answer from amongst the four alternatives for the unsolved equation.

$$7 \times 5 \times 6 = 576,$$

$$4 \times 2 \times 5 = 245,$$

$$8 \times 2 \times 5 = ?$$

A 258

B 285

C 582

D 852

Answer: B**Explanation:**

The pattern is that the first two numbers are swapped and the third number is written as it is.

$$\text{Eg} = 7 \times 5 \times 6 = 576$$

$$\text{and } 4 \times 2 \times 5 = 245$$

$$\text{Similarly, } 8 \times 2 \times 5 = 285$$

=> Ans - (B)

Question 91

Find the missing term in the following question:-

3	4	9
2	5	2
6	7	?
36	140	18

A 1

B 7

C 12

D 19

Answer: A**Explanation:**

In each column, the number at the end is obtained by multiplying the other three.

$$\text{Eg : } 3 \times 2 \times 6 = 36$$

$$\text{and } 4 \times 5 \times 7 = 140$$

Similarly, $9 \times 2 \times x = 18$

$$\Rightarrow x = \frac{18}{18} = 1$$

\Rightarrow Ans - (A)

Question 92

Pranav went 10 Km to the North. Then he turned West and covered 10 Km. Then he turned south and covered 5 Km. Finally, he turned to the East and covered 10 Km. In which direction he is from the starting point?

- A South
- B North
- C East
- D West

Answer: B

Explanation:

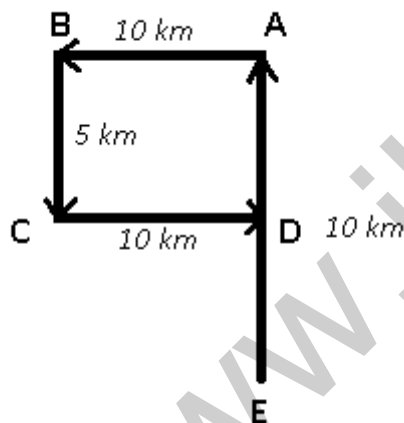

Let Pranav started from point E and walked towards point A for 10 km, then he turned left and walked for 10 km to reach B, then again he turned left and travelled south for 5 km, and finally stopped at point D after walking 10 km.

Thus, he is in north direction from starting point.

\Rightarrow Ans - (B)

Question 93

Consider the given statement/s to be true and decide which of the given conclusions/assumptions can definitely be drawn from the given statement. Statement: Many books are rocks. All rocks are clips.

Conclusion I: Some books are clips. II: No rock is a book.

- A Only conclusion I follows

- B Only conclusion II follows
- C Both conclusion I and conclusion II follow
- D Neither conclusion I nor conclusion II follows

Answer: A

Explanation:

The venn diagram for above statements is :

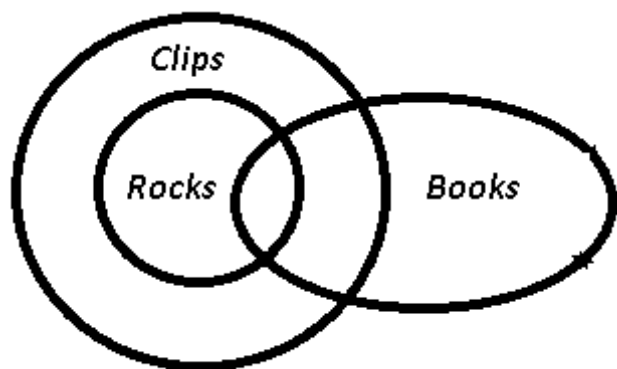

Conclusion I: Some books are clips = true

II: No rock is a book = false

Thus, only conclusion I follows

=> Ans - (A)

Question 94

Four different views of a cube/dice are given as viewed from different angles. Find out the number of dots on the face opposite to the face with one dot.

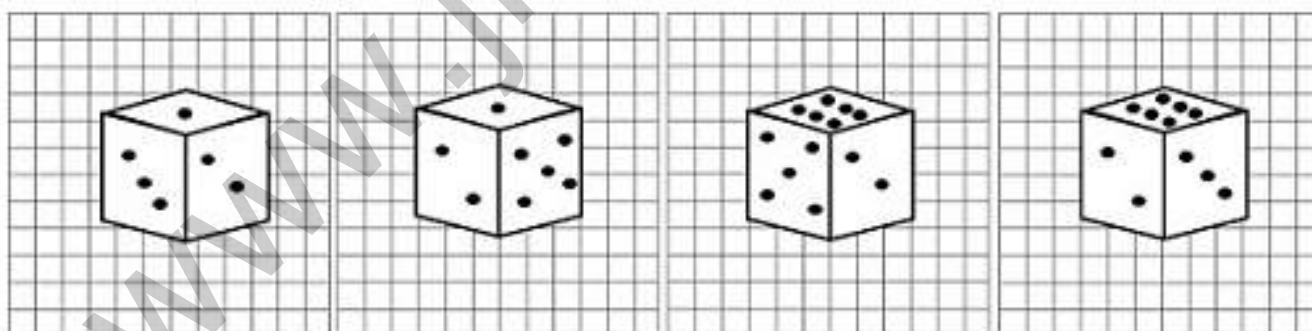

- A 6
- B 5
- C 4
- D 3

Answer: A

Explanation:

From the first two figures, we find that the side with 1 dot has adjacent sides having '2,3,5' dots.

Also, from the last two figures, the side with 6 dots has the same adjacent sides.

Thus, number of dots on the face opposite to the face with one dot = 6

=> Ans - (A)

Question 95

Choose from the four diagrams given below, the one that illustrates the relationship among 'Languages', 'French' and 'German'.

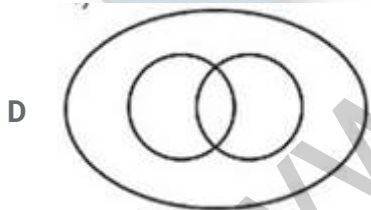
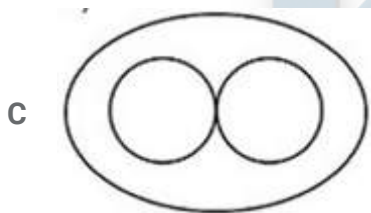
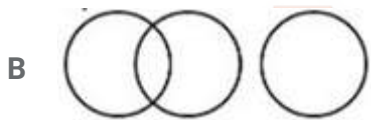
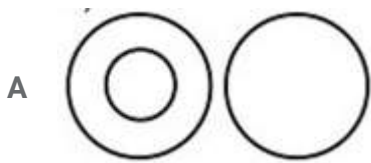

Answer: C

Explanation:

German and French are both languages but are completely different, thus the third figure best describes above relationship.

=> Ans - (C)

Question 96

Which answer will complete the pattern in the question figure?

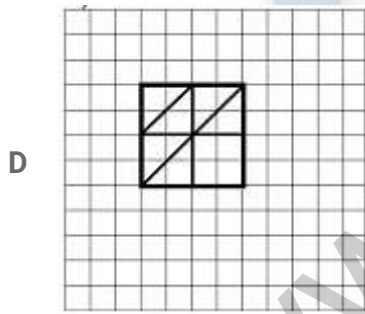
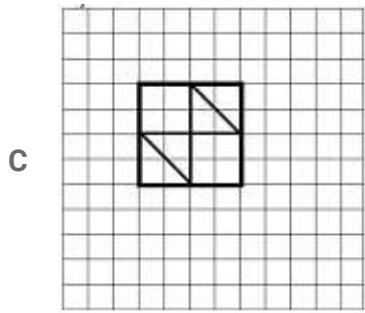
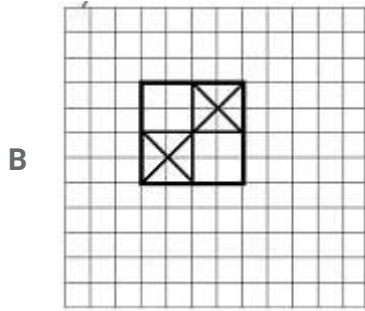
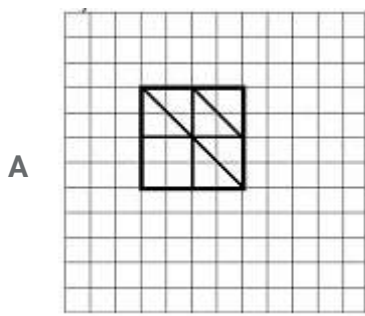

Answer: A

Question 97

From the given answer figures, select the one in which the question figure is hidden/embedded.

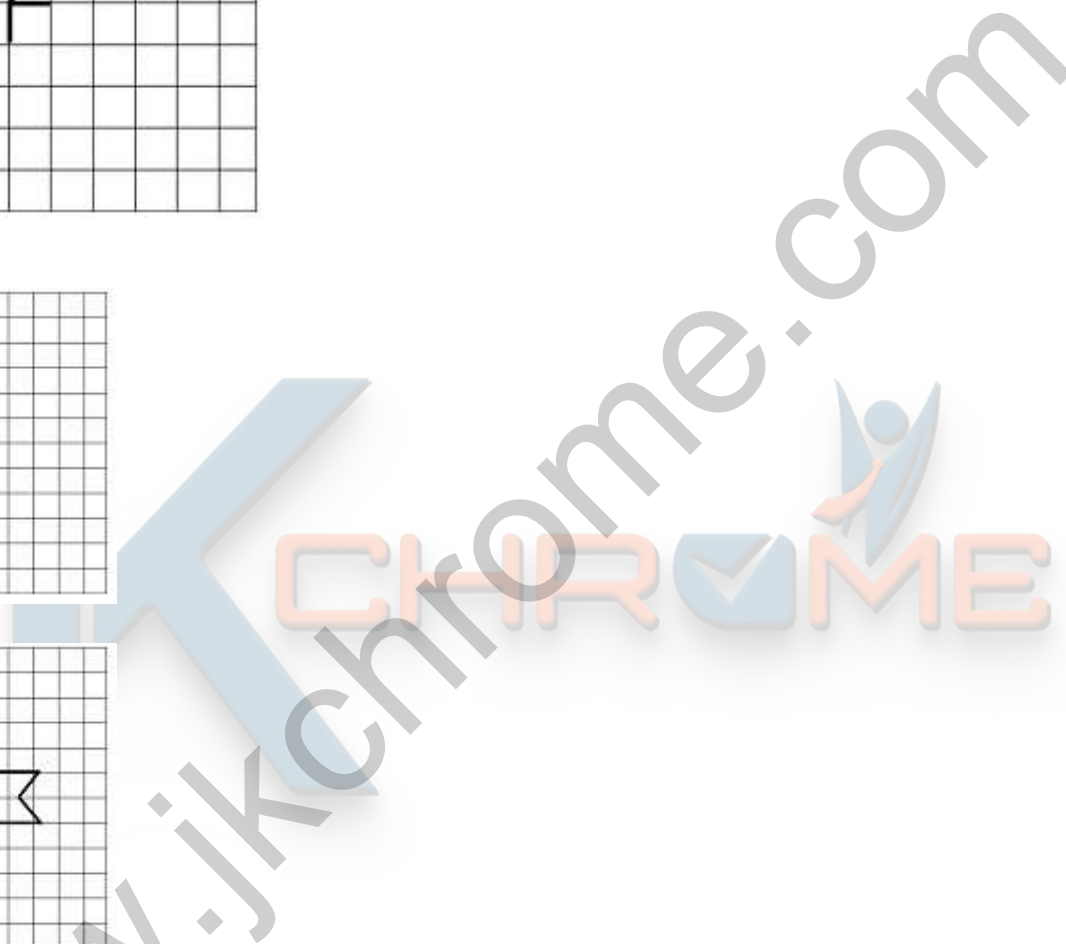
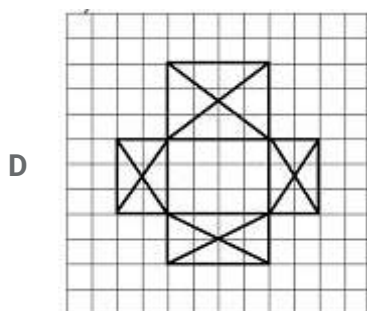
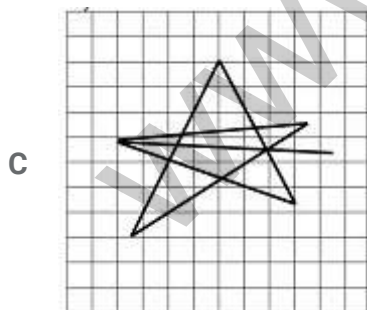
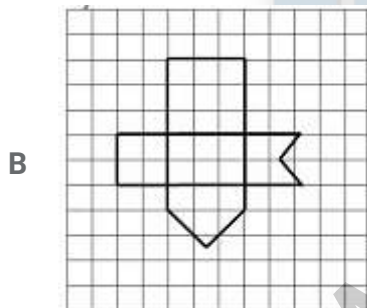
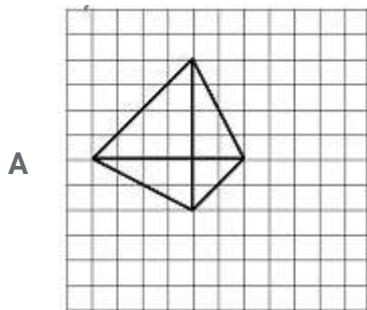
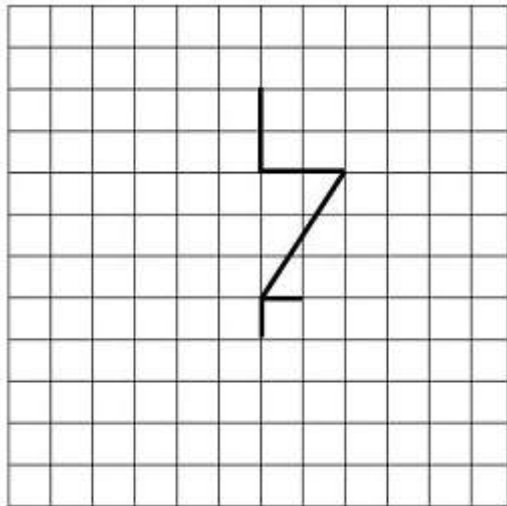

Answer: D

Explanation:

The question figure is embedded in the following figure :

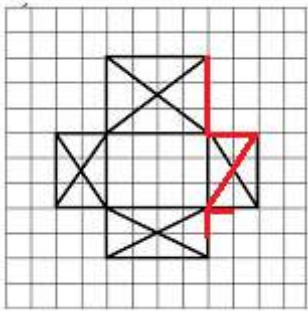

=> Ans - (D)

Question 98

A piece of paper is folded and cut as shown below in the question figures. From the given answer figures, indicate how it will appear when opened.

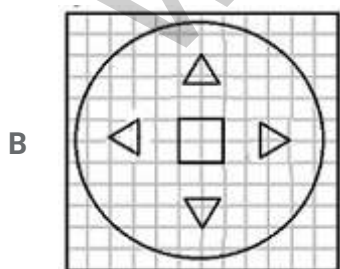
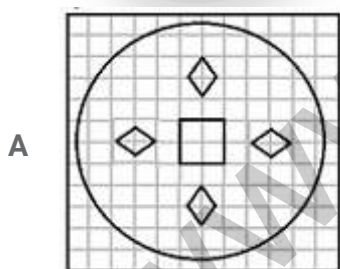
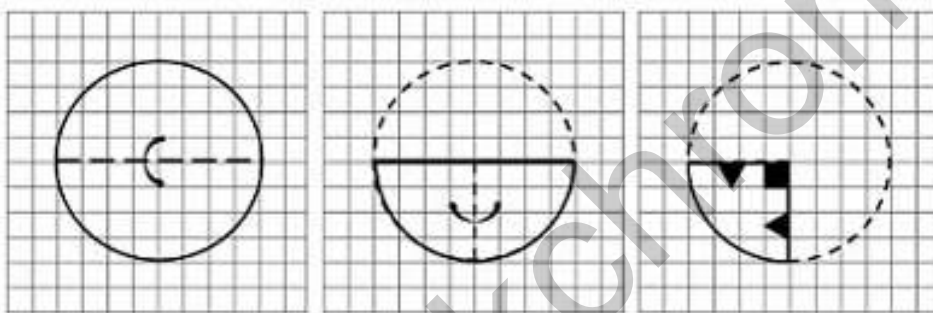

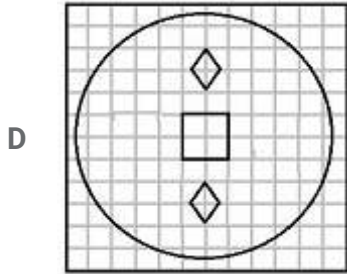
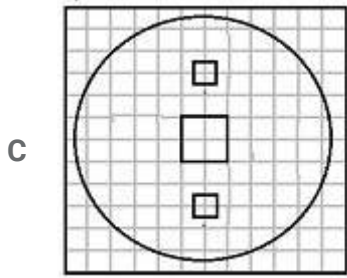

Answer: A

Question 99

If a mirror is placed on the line MN, then which of the answer figures is the right image of the given figure?

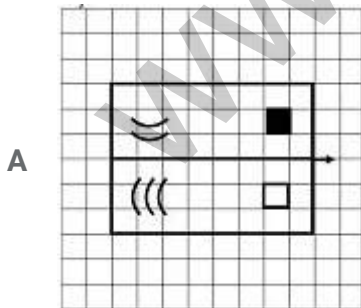
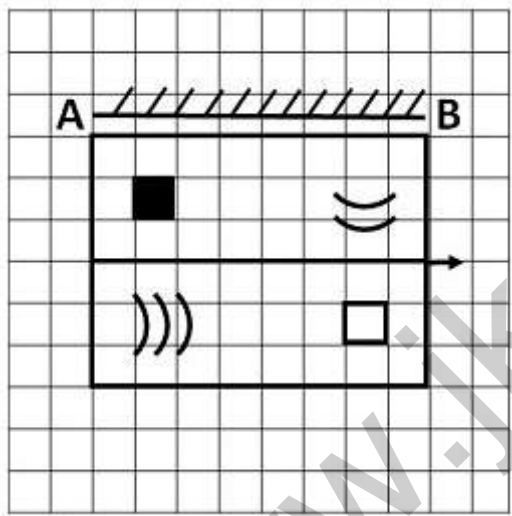

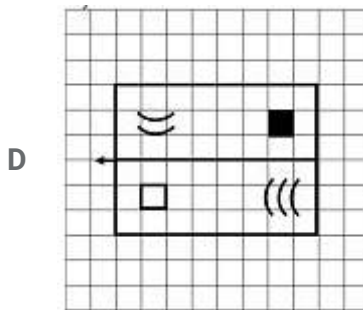
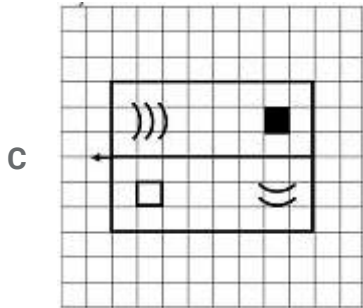
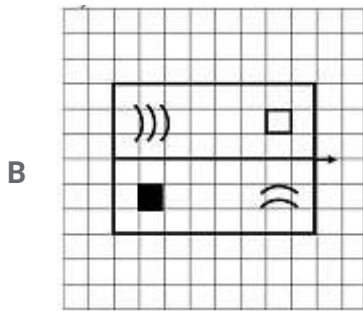

Answer: B

Explanation:

A horizontal mirror is placed, so the objects will turn upside down in the mirror image (e.g - an object at top right will appear at bottom right). So, the arrow in the middle pointing at right will have the same position in the mirror image, hence last two options are eliminated.

Also, the black square at top left will appear at bottom left as shown in second figure.

=> Ans - (B)

Question 100

In the question, a word is represented by only one set of numbers as given in any one of the alternatives. The sets of numbers given in the alternatives are represented by two classes of alphabets as in two matrices given below. The columns and rows of Matrix I are numbered from 0 to 4 and that of Matrix II are numbered from 5 to 9. A letter from these matrices can be represented first by its row and next by its column, e.g., O can be represented by 02,14, etc., and P can be represented by 55,67,, etc. You have to identify the set for the word 'NECK'.

Matrix - I

	0	1	2	3	4
0	L	E	O	S	C
1	S	C	L	E	O
2	E	O	S	C	L
3	C	L	E	O	S
4	O	S	C	L	E

Matrix - II

	5	6	7	8	9
5	R	K	U	N	T
6	N	T	R	K	U
7	K	U	N	T	B
8	T	R	K	U	N
9	U	N	T	R	K

A 96,32,34,68

B 77,13,69,75

C 65,21,58,99

D 89,44,30,87

Answer: D

Explanation:

(A) : 96,32,34,68 = NESK

(B) : 77,13,69,75 = NEUK

(C) : 65,21,58,99 = NONK

(D) : 89,44,30,87 = **NECK**

=> Ans - (D)





JK Chrome

JK Chrome | Employment Portal



Rated No.1 Job Application of India

Sarkari Naukri
Private Jobs
Employment News
Study Material
Notifications



JOBS



NOTIFICATIONS



G.K



STUDY MATERIAL



JK Chrome

jk chrome
Contains ads



www.jkchrome.com | Email : contact@jkchrome.com