



JK Chrome

JK Chrome | Employment Portal



Rated No.1 Job Application of India

Sarkari Naukri
Private Jobs
Employment News
Study Material
Notifications



JOBS



NOTIFICATIONS



G.K



STUDY MATERIAL



JK Chrome

jk chrome
Contains ads



www.jkchrome.com | Email : contact@jkchrome.com

Mirror and Water Images

Mirror Images

In this category questions are based on the criteria that a few figures are given and you have to find out which one is the exact image of the given figure in a mirror placed in front of it. This image formation is based on the principle of 'lateral inversion' which implies that size of the image is equal to the size of the object but both sides are interchanged. The left portion of the object is seen on the right side and right portion of the object is seen on the left side. For example, mirror image of ABC = CBA.

Note : There are '11' letters in English Alphabet which have identical mirror images: A, H, I, M, O, T, U, V, W, X, Y.

Characteristics of Reflection by plane mirror

1. Perpendicular distance of object from mirror = Perpendicular distance of image from mirror.
2. The image is laterally inverted.

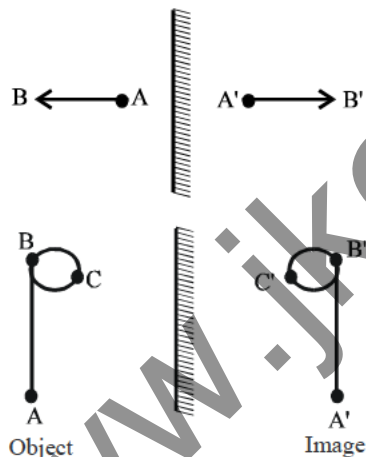

3. The line joining the object point with its image is normal to the reflecting surface.
4. The size of the image is the same as that of the object.

E.g -1: Mirror-images of certain words are given below :

- (1) FUN : FUN
 (2) GOLKONDA : AONKONDA

E.g -2: Mirror-image of certain combinations of alphabets and numbers are given below :

- (1) BMC49JN2317 : 7132JN94CMB
 (2) 15bg82XQh : h1p82XQh

I. Mirror Images of Capital Letters

A	A	N	N
B	B	O	O
C	C	P	q
D	D	Q	Q
E	E	R	Я
F	F	S	z
G	G	T	T
H	H	U	U
I	I	V	V
J	J	W	W
K	K	X	X
L	L	Y	Y
M	M	Z	Z

II. Mirror Images of Small Letters

a	s	n	n
b	d	o	o
c	c	p	q
d	b	q	p
e	e	r	r
f	f	s	z
g	g	t	t
h	h	u	u
i	i	v	v
j	j	w	w
k	k	x	x
l	l	y	y
m	m	z	z

III. Mirror Images of Numbers

0	0	6	9
1	1	7	7
2	2	8	8
3	3	9	6
4	4	10	01
5	5		

Examples of lateral inversion of few figures and words are given below :

IV. Mirror Images of Various Objects :

Objects	Mirror images	Objects	Mirror images

V. Mirror Images of Certain Words and Numbers:

Words	Mirror images	Numbers	Mirror images
PREDICTION	NOITICION	32596	62593
HOSPITAL	LATIPSOH	8932	2398
DARPAN	NARPAN	868	868
STRIDENT	TNRIDETS	786	687
OPULENT	TNULPO	10190	01901
SARCASM	MZACRMS	5693	3965
LIBERAL	LIRBAL	8964	4698
OFFENCE	ECNCFE	7362	2367
ADVANCE	ECNVA	5893	3985
IMAGES	SEGI	7839	9387

VI. Mirror Images of Clock:

There are certain questions in which the position of the hour-hand and the minute-hand of a clock as seen in a mirror are given. On the basis of the time indicated by the mirror-image of the clock we have to detect the actual time in the clock. In the solution of such questions we use the fact that if an object A is the mirror-image of another object B then B is the mirror-image of A.

Time of image in plane mirror

- (a) Real time = X^H , Image time = $12^H - X^H$ (H = hours)
 (b) Real time = $X^H Y^M$, Image time = $11^H 60^M - X^H Y^M$ (M = minutes)
 (c) Real time = $X^H Y^M Z^S$, Image time = $11^H 59^M 60^S - X^H Y^M Z^S$ (S = seconds)
 (d) if $X^H Y^M Z^S > 11^H 59^M 60^S$, image time = $23^H 59^M 60^S - X^H Y^M Z^S$

Quick Tip

Whenever you have to solve a mirror image question, imagine a mirror placed in front of the object and then try to find its inverted image. The portion of the object that is near the mirror will now be the portion of the image near to the mirror in the inverted form.

ILLUSTRATION 1 :

By looking in a mirror, it appears that it is 6 : 30 in the clock.

What is the real time ?

- (1) 6 : 30 (2) 5 : 30
 (3) 6 : 00 (4) 4 : 30

Sol. (2)

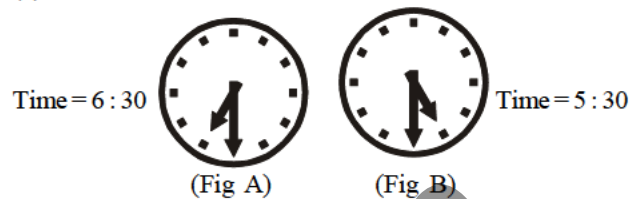

Clearly, fig (A) shows the time (6 : 30) in the clock as it appears in a mirror. Then its mirror-image i.e. Fig (B) shows the actual time in the clock i.e. 5 : 30. You can solve it quickly if you remember that the sum of actual time and image time is always 12 hours.

DIRECTIONS (ILLUSTRATION 2-6) :

Find the correct option for the mirror image for the following examples.

ILLUSTRATION 2 :

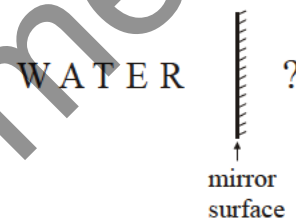

- (1) W A T E R (2) R E T E W
 (3) W A R E T (4) R E T A W

Sol. (4) We have to find the correct mirror image for the word 'WATER' for which we need to find the mirror image for each letter separately and then arrange it, like the mirror image for the letters W is W, A is A, T is T, E is E and R is R. Since, the word ends with R, i.e., where the mirror is placed, therefore the mirror image will start from the mirror images of R, i.e.; R. Thus the mirror image for water is R E T A W



Thus option (4) is the correct answer.

ILLUSTRATION 3 :

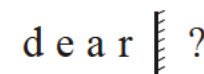

- (1) b e s r (2) r e s b
 (3) d e s r (4) r e s b

Sol. (2) Mirror image for 'd' is 'b', 'e' is 'e', 'a' is 's' and 'r' is 'r'

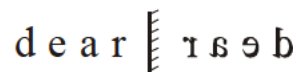

Thus, option (2) is the correct answer.

ILLUSTRATION 4:

8 6 9 5 2 | ?

- (1) 8 ॐ 9 २ ५ (2) 8 9 ॐ 5 ५
 (3) 8 ॐ २ ५ ॐ (4) ५ २ ॐ ॐ 8

Sol. (4) Mirror image for '8' is '8', '6' is 'ॐ', '9' is 'ॐ', '5' is '२' and '2' is '५'.

8 6 9 5 2 | ५ २ ॐ ॐ 8

Thus, option (4) is the answer.

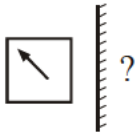
ILLUSTRATION 5:

- (1) (2)
 (3) (4)

Sol. (1) The mirror image of a square remains a square while the arrow inside it will be changed.

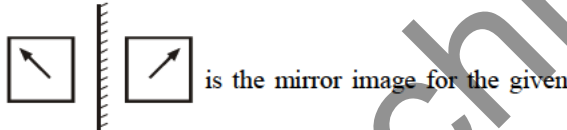
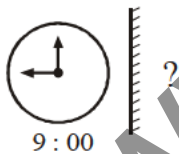
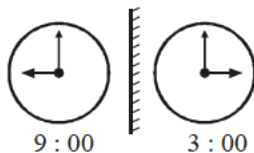

image. Thus option (1) is the correct answer.

ILLUSTRATION 6:

- (1) 12:00 (2) 5:00
 (3) 3:00 (4) 6:00

Sol. (3) The mirror image of circle remains a circle, and the arrow facing north also remains the same but the arrow facing will face East in its mirror image.



Thus, answer is 3 : 00, i.e., option C.

Water Image

The reflection of an object as seen in water is called its water image. It is the inverted image obtained by turning the object upside down.

Water-images of capital letters

Letters	A B C D E F G H I J K L M
Water-image	V B C D E E C H I 1 K Γ W
Letters	N O P Q R S T U V W X Y Z
Water-image	И O Ъ Ó Ъ 2 L П Λ Μ X Λ 5

Water-images of small letters

Letters	a b c d e f g h i j k l m
Water-image	σ ρ c q e t Ɔ p ı ı k j w
Letters	n o p q r s t u v w x y z
Water-image	u o b d i 2 r π λ μ x λ 5

Water-images of numbers

Letters	0 1 2 3 4 5 6 7 8 9
Water-image	0 1 5 3 4 2 ॐ 1 8 ॐ

Note :

- The letters whose water-images are identical to the letter itself are : C, D, E, H, I, K, O, X
- Certain words which have water-images identical to the word itself are :
KICK, KID, CHIDE, HIKE, CODE, CHICK

Quick Tip

Whenever we have to analyze the water image of an object, imagine a mirror or a surface that forms an image just under the given object. The portion of the object that is near the water surface will be inverted but will be near the water surface in the image as well.

DIRECTIONS (ILLUSTRATION 7-11):

Find the correct option for the water images for the following examples.

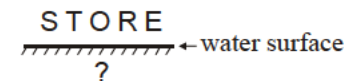
ILLUSTRATION 7:

- (1) S L O R E (2) S L O Ɔ E
 (3) S L O B E (4) 2 L O B E

Sol. (4) In case of water image, the water reflection will usually be formed under the object / word.

In this case, the water image of the word will be an outcome of the water images of each of the letters like, the water images of S is Ɔ, T is 1, O is O, R is B and E is E. Thus the water image of the word 'STORE' is '2 L O B E.'



ILLUSTRATION 8 :

scary

 ?

- (1) s c a i l (2) s c a l i
 (3) s c a j l (4) s c a j i

Sol. (1) The water image of 's' is 's', 'c' is 'c', 'a' is 'a', 'r' is 'r' and 'y' is 'y'

Thus the water images of scary is 's c a i l'.

ILLUSTRATION 9 :

1 6 8 9 2

 ?

- (1) 1 0 8 0 5 (2) 1 0 8 0 5
 (3) 1 0 8 0 5 (4) 1 0 8 6 5

Sol. (2) The water image of '1' is 1, '6' is '0', '8' is 8, '9' is '0' and '2' is '5'.

Thus, the water image of 1 6 8 9 2 is 1 0 8 0 5

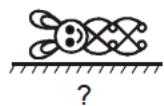
ILLUSTRATION 10 :

- (1) (2)
 (3) (4)

Sol. (1) Since, the teddy bear is facing west, in its water image also it will face west. Therefore, options (2) & (3) are ruled out.

Now among options (1) & (4) check the ears and nose of the bear in the actual diagram, it does not have a nose, but the image in option (4) has a nose. Therefore, option (1) is the correct representation.

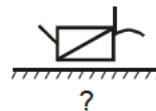
ILLUSTRATION 11 :

- (1) (2)
 (3) (4)

Sol. (3) Observe the object carefully, the rectangle will remain a rectangle, the diagonal in the object starts from near the water surface in the west side and so will start in the image on the west side. And the arc that is facing North west, will face south-west in the image. Thus option (3) is the correct answer.

Quick Tips

- (i) While solving a question, try eliminating some options and solving the questions will become easier. To eliminate options, keep in mind the pattern used in the object (given diagram whose image is to be formed) as well as the position of mirror or water such that the portion of the object near to the mirror / water will produce the same portion near the mirror / water in an inverted form.
- (ii) Images are images, be it water or mirror, in both the cases an inverted image of the alphabets / numerals / clocks / any other object are formed by inverting the object. Inverting of the object solely depends upon the position of mirror or water surface w.r.t. the object.

Exercise**1****Mirror Images**

DIRECTIONS (Q.1 to Q.15) : Find the correct option for the mirror images for the following questions.

1. DREAM ?
 (1) MAERD (2) MAERD
 (3) MAERD (4) MAERD

2. NEWS ?
 (1) SWEN (2) SWEN
 (3) SWEN (4) SWEN

3. jealous ?
 (1) j e a l o u s (2) j e a l o u s
 (3) s o u l e a j (4) a u o l e a j

4. 312568 ?
 (1) 3 1 2 5 6 8 (2) 8 6 5 2 1 3
 (3) 8 0 5 2 0 8 (4) 8 0 5 2 0 8

5. Rotate the mirror image 90° clockwise.

- (1) (2)
 (3) (4)

6. Rotate the mirror image 90° anticlockwise.

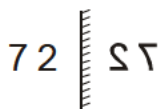

- (1) 27 (2) ΣΤ
(3) ΣΤ (4) ΣΛΣ

7. Rotate the mirror image 90° clockwise.

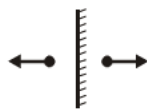

- (1) ↑ (2) ←
(3) → (4) ↓

8. Rotate the mirror image of the given clock 90° clockwise and the time will be.

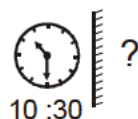

- (1) 4:45 (2) 5:45
(3) 3:45 (4) 4:30

9. Rotate the mirror image 90° clockwise.

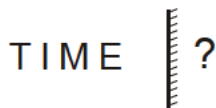

- (1) TIME (2) MITE
(3) TIME (4) TIME



- (1) 2:45 (2) 3:15
(3) 9:15 (4) 9:45

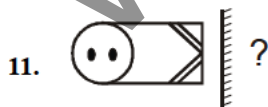

- (1) [diagonal line] [dots] (2) [diagonal line] [dots]
(3) [circle] [diagonal line] (4) [dots] [diagonal line]

12. Rotate the mirror image 90° anticlockwise.

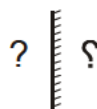

- (1) ? (2) ?
(3) ? (4) ?

13. Rotate the mirror image 90° anticlockwise.



- (1) TNA (2) TNA
(3) ANT (4) ANT

14. Rotate the mirror image 90° anticlockwise.



- (1) 6:15 (2) 6:05
(3) 5:05 (4) 5:15

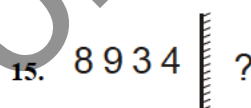

- (1) 8934 (2) 8934
(3) 8934 (4) 4938

DIRECTIONS (Qs. 16-18) : In each of the following questions, you are given a combination of alphabets and/or numbers followed by alternatives (1), (2), (3) and (4). Choose the alternative which most closely resembles the mirror image of the given combination.

16. NATIONAL

- (1) LANOILAN (2) LANOITAN
(3) LANOITAN (4) LANOITAN

17. ANS43Q12

- (1) ANS43Q12 (2) ANS43Q12
(3) ANS43Q12 (4) ANS43Q12

18. 1965INDOPAK

- (1) 1962INDOPAK (2) 1962INDOPAK
(3) 1962INDOPAK (4) 1962INDOPAK

19. Which of the following collection of letters will look the same in the mirror ?

- (1) OSMIHOM (2) VHRTRVH
(3) HIMOSTA (4) AOVIVOA

DIRECTIONS (Qs. 20-28) : In each of the following questions, choose the correct mirror-image of the Fig. (X) from amongst the four alternatives (1), (2), (3) and (4) given along with it.

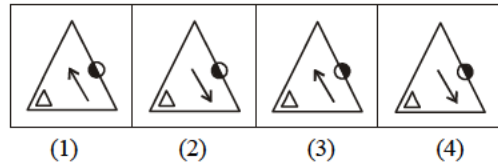
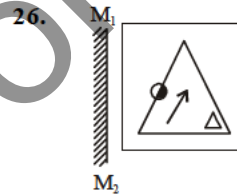
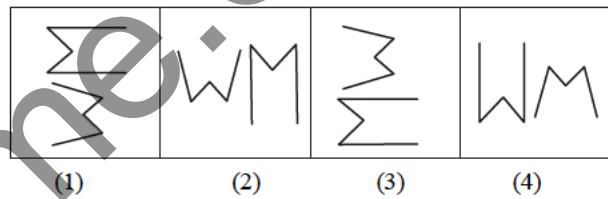
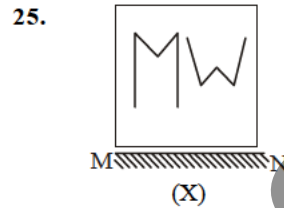
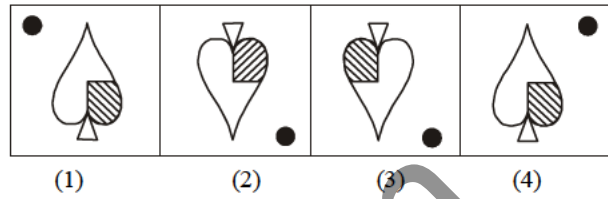
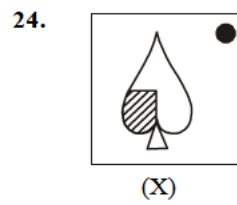
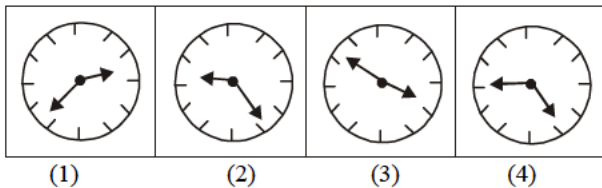
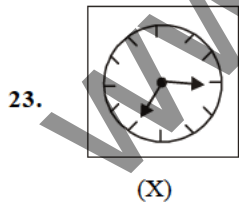
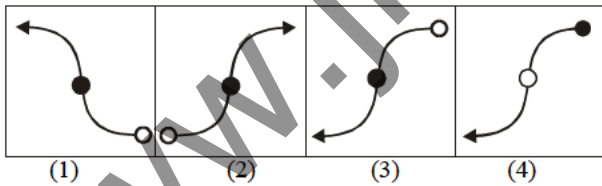
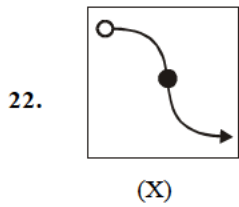
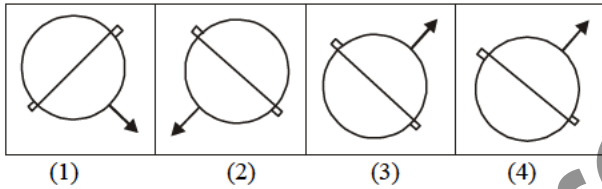
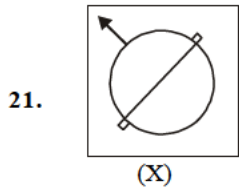
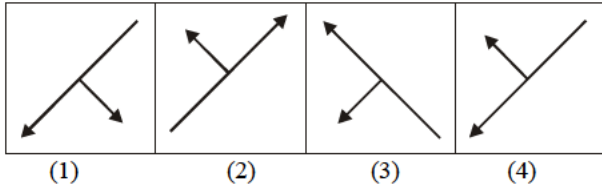
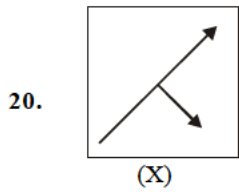

27. Looking into a mirror, the clock shows 9 : 30 as the time. The actual time is

- (1) 2 : 30 (2) 3 : 30
(3) 4 : 30 (4) 6 : 30

28. A clock seen through a mirror shows quarter to three. What is the correct time shown by the clock ?

- (1) 8 : 15 (2) 9 : 12
(3) 8 : 17 (4) 9 : 15



DIRECTIONS (Qs. 29-32) : In each of the following questions, you are given a combination of alphabets and/or numbers followed by four alternatives (1), (2), (3) and (4). Choose the alternative which most closely resembles the mirror-image of the given combination.



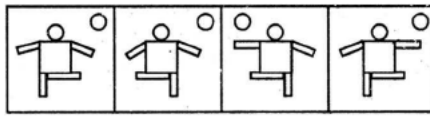
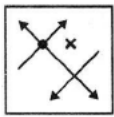
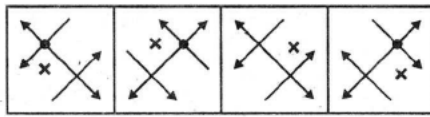

29. WHITE

- (1) LIHW (2) TIHW
(3) TIHW (4) ETIHW

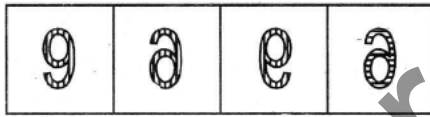
30. TERMINATE
 (1) TЯMЯMATE (2) ETAMINATE
 (3) ETAMINATE (4) ETAMINATE
31. REASONING
 (1) RЯNOZAFЯ (2) RЯNOING
 (3) RЯNOZAFЯ (4) RЯNOING
32. BR4AQ16HI
 (1) BR4AQ16HI (2) BR4AQ19HI
 (3) BR4AQ16HI (4) BR4AQ16HI

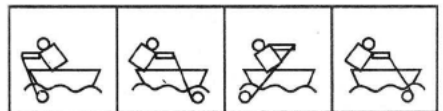
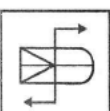
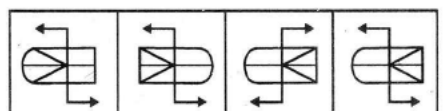
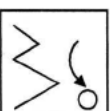
DIRECTIONS (Qs. 33-40) : In each of the following questions, choose the correct mirror-image of the Fig. (X) from amongst the four alternatives (1), (2), (3) and (4) given along with it.

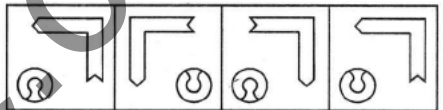
33.  (X) 
 (X) (1) (2) (3) (4)
34.  (X) 
 (X) (1) (2) (3) (4)
35.  (X) 
 (X) (1) (2) (3) (4)

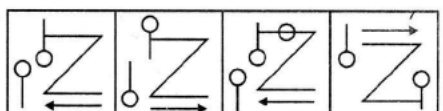
36.  (X) 
 (X) (1) (2) (3) (4)
37.  (X) 
 (X) (1) (2) (3) (4)
38.  (X) 
 (X) (1) (2) (3) (4)
39.  (X) 
 (X) (1) (2) (3) (4)
40.  (X) 
 (X) (1) (2) (3) (4)

Exercise

2

Water Images

DIRECTIONS (for Q.1 to Q.15)

Find the correct option for the water images for the following questions.

1. PLEDGE
 ?
 (1) PГEDGE (2) ʘГEDGE
 (3) ʘГEDGE (4) ʘГEDGE
2. heLP
 ?
 (1) hеP (2) ʘheP
 (3) ʘheP (4) ʘheP
3. DOLLAR
 ?
 (1) DOLLAR (2) DOLLAR
 (3) DOLLAR (4) DOLLAR

4. absence
 ?
 (1) spsence (2) sqsence
 (3) spsencə (4) spsence
5. 918423
 ?
 (1) ɔ18423 (2) ɔ18423
 (3) ɔ18423 (4) ɔ18423
6. What will be the water image of given diagram?
 ?
 (1) ı (2) ʘ
 (3) ı (4) ı
7. gLad
 ?
 (1) ɔГad (2) ɔГad
 (3) ɔГad (4) ɔГad

8. SNOW
?
(1) SNOM (2) SNOM
(3) SNOM (4) SNOW





9. drain
?
(1) drain (2) drain
(3) drain (4) drain





10. ZEBRA
?
(1) ZEBBA (2) ZEBBA
(3) ZEBBA (4) ZEBBA

11. 671
?
(1) 671 (2) 671
(3) 671 (4) 671

12. 9283
?
(1) 9283 (2) 9283
(3) 9283 (4) 9283

DIRECTIONS (Qs. 13-20) : In each of the following questions, choose the correct water image of the figure (X) from amongst the four alternatives (1), (2), (3), (4) given along with it.

13. 
(X)
(1) 
(2) 
(3) 
(4) 

14. 
(X)
(1) 
(2) 
(3) 
(4) 

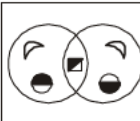

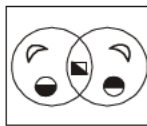
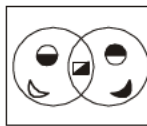
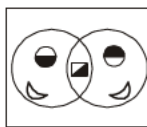
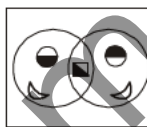

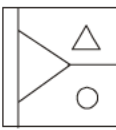
15. 
(X)

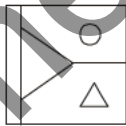
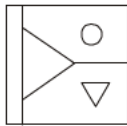
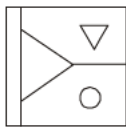
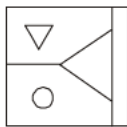
- (1) 
(2) 
(3) 
(4) 



16. 
(X)

- (1) 
(2) 
(3) 
(4) 

17. 
(X)

- (1) 
(2) 
(3) 
(4) 

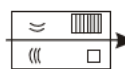
18. 
(X)

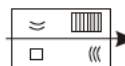
- (1) 
(2) 
(3) 
(4) 

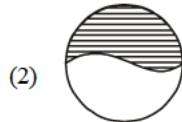
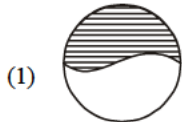
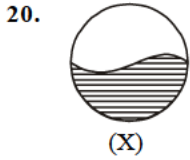
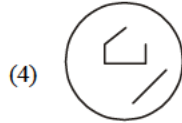
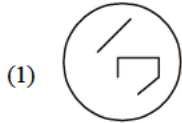
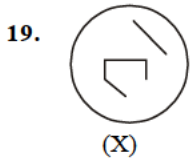

DIRECTIONS (Qs. 21-24) : In each of the following questions, you are given a combination of alphabets and/or numbers followed by four alternatives (1), (2), (3) and (4). Choose the alternative which most closely resembles the water image of the given combination.

21. FROG

(1) EBOG

(2) GORF

(3) GORF

(4) EBOG

22. U4P15B7

(1) U4P12B7

(2) U4P12B7

(3) U4P12B7

(4) U4P12B7

23. GR98AP76ES

(1) GR68VBJ9E2

(2) GR08VBJ9E2

(3) GR08VBJ9E2

(4) GR08ABJ9E2

24. A1M3b

(1) A1M3P

(2) A1M3P

(3) A1M3P

(4) A1M3P

DIRECTIONS (Qs. 25-28) : In each of the following questions, choose the correct water image of the figure (X) from amongst the four alternatives (1), (2), (3) and (4) given along with it.

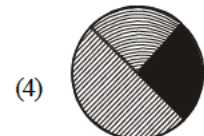
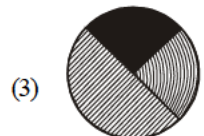
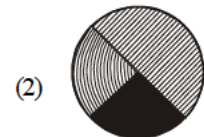
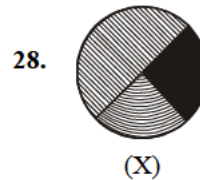
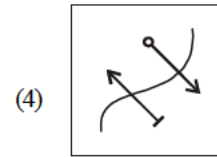
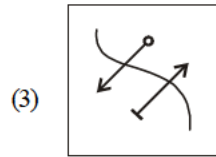
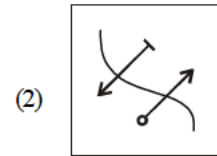
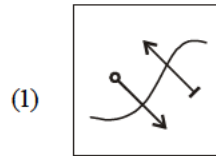
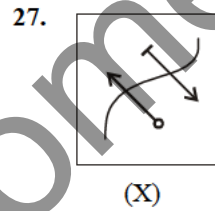
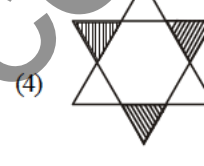
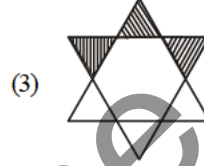
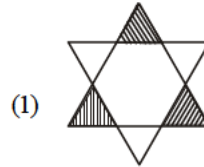
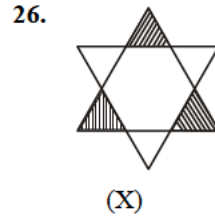
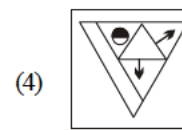
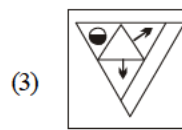
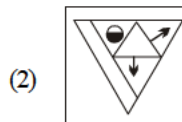
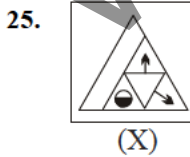

29. Observe the figures below :

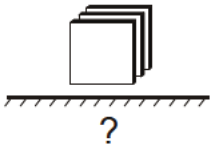

First rotate the figure by 90° in clock-wise direction and find out its water reflection from the given alternatives (NTSE)

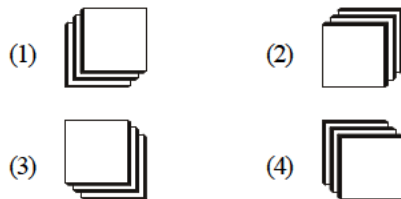

30.

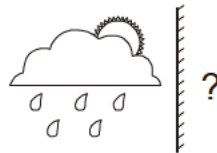

If the mirror image of the figure is rotated to 90° in clockwise direction, it will look like :

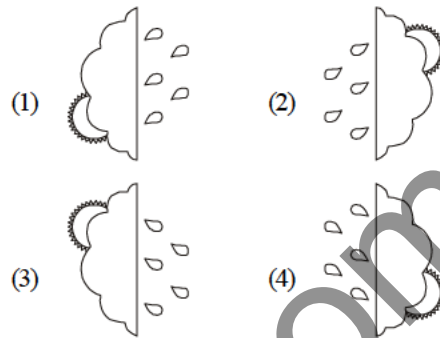

Hints & SOLUTIONS

Exercise - 1

- (3) Mirror image for the letters 'D' is 'D', 'R' is 'R', 'E' is 'E', 'A' is 'A' and 'M' is 'M'. Since the word ends with M, i.e., where the mirror is placed, therefore the mirror image will start from the mirror image of M, i.e., M. Thus the mirror image for water is MÆRD.
- (1) Mirror image for the letters 'N' is 'N', 'E' is 'E', 'W' is 'W' and 'S' is 'S'.
- (4) Mirror image for the letters 'j' is 'j', 'e' is 'e', 'a' is 'a', 'L' is 'L', 'O' is 'O', 'u' is 'u' and 'S' is 'S'.
- (4) Mirror image of numbers—'3' is '3', '1' is '1', '2' is '2', '5' is '5', '6' is '6' and '8' is '8'.
- (2) If we rotate the mirror image, i.e., 'B' 90° clockwise, then it will be 'm'.
- (3) If we rotate the mirror image, i.e., 'Z' to 90° anticlockwise, then it will be 'Z'.
- (4) If we rotate the mirror image, i.e., '→' to 90°

clockwise, then it will be '↓'

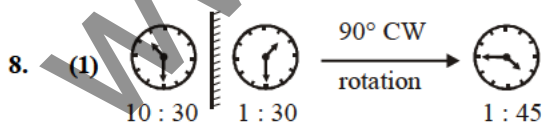

Hence, option (1) is the answer.



Hence, option (3) is the correct answer.

- (1) The mirror image of circle remains a circle and the arrow facing west will face towards east and arrow facing east will face towards west. Thus, time will be 2 : 45.

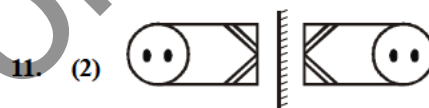

Hence option (2) is the answer.

- (1) If we rotate the mirror image, i.e., 'ζ' to 90° anti-clockwise, then it will be 'ζ'. Thus, option (1) is the answer.
- (2) If we rotate the mirror image i.e., 'TIA' to 90° anti-clockwise, then it will be 'TIA'. Thus, option B is the answer.
- (2) The mirror image of circle remains a circle. The arrow facing south will also remain the same. But the arrow facing north-west will face north-east.

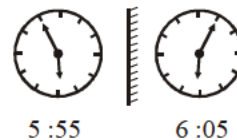

- (4) Mirror images for the numbers '8' is '8', '9' is '9', '3' is '3' and '4' is '4'.
- (2)
- (2)
- (4)
- (4)
- (3) Assume that the mirror is placed on the right hand side of the given object, unless mentioned or drawn near the object.

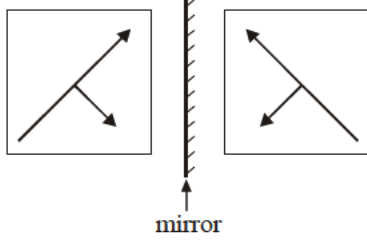

21. (3)

22. (3)

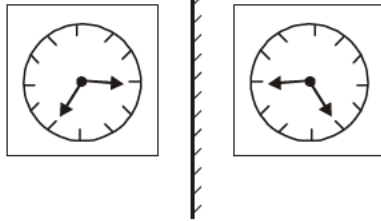

23. (4)

24. (1)

25. (2) This object has mirror placed under the object.

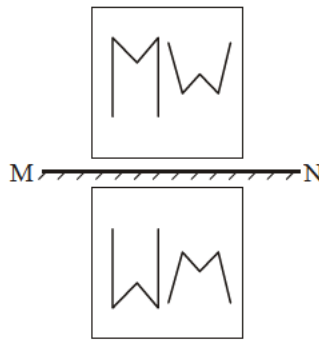

26. (1)

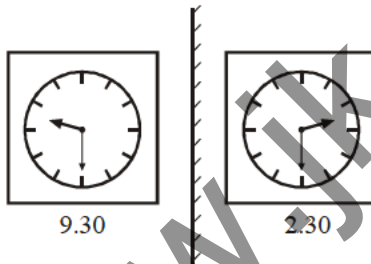

27. (1)

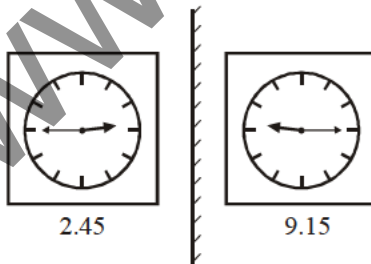

28. (4)

29. (3) 30. (3) 31. (2) 32. (1)

33. (4) 34. (2) 35. (2) 36. (4)

37. (4) 38. (3) 39. (1) 40. (3)

1. (3) The water image of 'P' is 'b', 'L' is 'Γ', 'E' is 'E', 'D' is 'D', 'G' is 'G' and 'E' is 'E'.
 2. (2) The water image of 'h' is 'μ', 'e' is 'e', 'L' is 'Γ' and 'P' is 'b'.
 3. (2) The water image of 'D' is 'D', 'O' is 'O', 'L' is 'Γ', 'A' is 'V' and 'R' is 'B'.
 4. (1) The water image of 'a' is 'g', 'b' is 'p', 'S' is 'Z', 'e' is 'e', 'n' is 'u', 'c' is 'c' and 'e' is 'e'.
 5. (4) The water image of number — '9' is 'θ', '1' is 'J', '8' is 'g', '4' is 'q', '2' is 'S' and '3' is '3'.
 6. (2) The water image of '?' is 'J'.
-
7. (3) The water image of 'g' is 'θ', 'L' is 'Γ', 'a' is 'g' and 'd' is 'q'.
 8. (1) The water image of 'S' is 'Z', 'N' is 'u', 'O' is 'O' and 'W' is 'M'.
 9. (2) The water image of 'd' is 'q', 'r' is 'L', 'a' is 'g', 'i' is 'i' and 'n' is 'u'.
 10. (3) The water image of 'Z' is 'S', 'E' is 'E', 'B' is 'B', 'R' is 'B' and 'A' is 'V'.
 11. (2) The water image of '6' is 'θ', '7' is 'Δ' and '1' is 'J'.
 12. (3) The water image of '9' is 'θ', '2' is 'S', '8' is 'g' and '3' is '3'.
 13. (1) Since, in case of water images, usually the image drawn is just under the actual object. So the shaded and dotted portion will come up on their respective sides, because the portion of the object near water surface will remain near the water surface in case of the image as well.

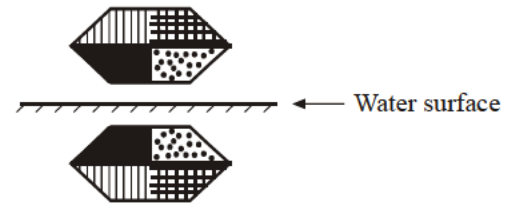

14. (4)

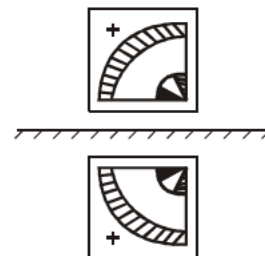

15. (4)

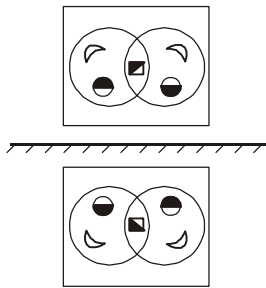

16. (2)

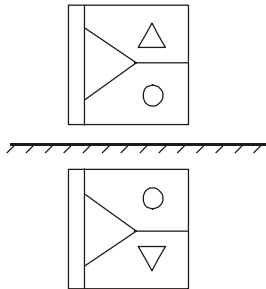

17. (3)

18. (1)

19. (4)

20. (3)

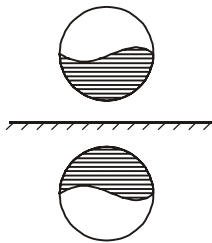

21. (1)

22. (3)

23. (3)

24. (3) 25. (4)

26. (4)

27. (3)

28. (4)

29. (2)

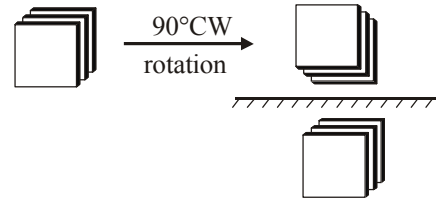

This is the final image

Thus option (2) is the correct answer.

30. (2)

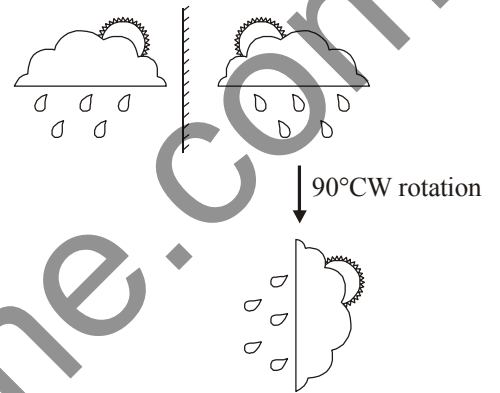

Final image

Hence option (2) is the answer.

www.jkchrome.com

MIRROR & WATER IMAGES

TYPE-I

Direction (1) : Which of the answer figures is exactly the mirror image of the given figure when the mirror is held at PQ?

(SSC Combined Graduate Level Prelim Exam. 27.02.2000 (First Sitting))

1. **Question Figure :**



Answer Figures :

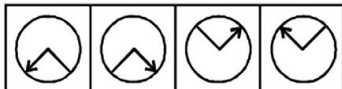

(1) (2) (3) (4)

2. Which of the answer figures is exactly the mirror image of the given figure when the mirror is held at MN?

Question Figure :



Answer Figures :

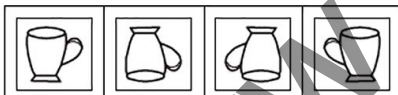

(1) (2) (3) (4)

(SSC CPO Sub-Inspector Exam. 03.09.2006)

3. Which of the answer figures is exactly the mirror image of the given figure when mirror is held as shown ?

Question Figure :

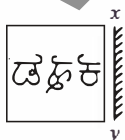

Answer Figures :

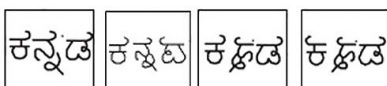

(1) (2) (3) (4)

(SSC CPO Sub-Inspector Exam. 09.11.2008)

Direction (4) : In the following question, which of the answer figures is exactly the mirror image of the question figure when the mirror is held at XY ?

(SSC CPO Sub-Inspector Exam. 06.09.2009)

4. **Question Figure :**



Answer Figures :



(1) (2) (3) (4)

5. Which answer figure is the exact mirror image of the given question figure when the mirror is held from the right at PQ ?

Question figure :



Answer figures :

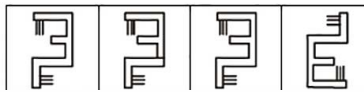

(1) (2) (3) (4)

(SSC Combined Graduate Level Tier-I Exam. 16.05.2010 (First Sitting))

6. If the mirror is placed on the line LM, then which of the answer figures is the right image of the given question figure ?

Question Figure :

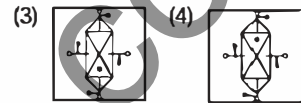
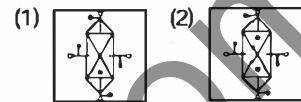
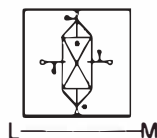

(SSC Combined Graduate Level Tier-I Exam. 16.05.2010)

(IInd Sitting)

7. If a mirror is placed on the northern side then which of the answer figures is the right image of the given question figure.

Question Figure :

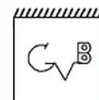

Answer figures :



(1) (2) (3) (4)

(SSC SAS Exam. 26.06.2010 (Paper-I))

Direction (8) : If a mirror is placed on the line MN, then which of the answer figures is the correct image of the given question figure?

(SSC Combined Graduate Level Prelim Exam. 19.06.2011 (1st Sitting))

8. **Question Figure :**

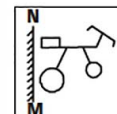

Answer Figures :

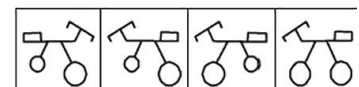

(1) (2) (3) (4)

Direction (9) : If a mirror is placed on the line MN, then which of the answer figures is the right image, of the given figure ?

(SSC Combined Graduate Level Prelim Exam. 19.06.2011 (1st Sitting))

MIRROR & WATER IMAGES

9. Question Figure :



Answer Figures :

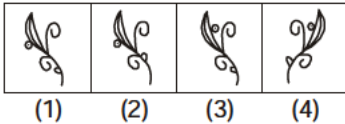

Direction (10) : If a mirror is placed on the line MN, then which of the answer figures is the correct image of the given question figure?

(SSC Combined Graduate Level Tier-1 Exam. 26.06.2011 (First Sitting))

10. Question Figure :

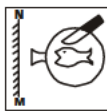

Answer Figures :

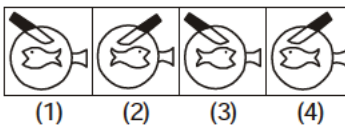

Direction (11) : If a mirror is placed on the line MN, then which of the answer figures is the correct image of the given Figure?

(SSC Combined Graduate Level Tier-1 Exam. 26.06.2011(Second Sitting))

11. Question Figure :



Answer Figures :

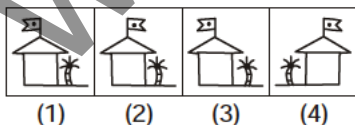

12. Which of the answer figures is exactly the mirror image of the question figure when the mirror is held at MX.

Question Figure :



Answer Figures :

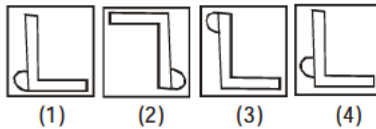

(SSC Combined Matric Level (PRE) Exam. 24.10.1999 (1st Sitting))

13. Which of the answer figures is exactly the mirror image of the given figure when the mirror is held at AB ?

Question Figure :



Answer Figures :

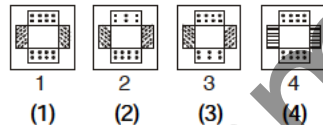

(SSC Combined Matric Level (PRE) Exam. 24.10.1999 (IInd Sitting))

14. Which of the following figures is exactly the mirror image of the question figure when the mirror is held at AB?

Question Figure :



Answer Figures :

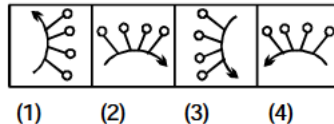

(SSC Combined Matric Level (PRE) Exam. 21.05.2000 (1st Sitting) (East Zone))

15. Which of the answer figures is exactly the mirror image of the question figure, when mirror is held at MN?

Question Figure :



Answer Figures :

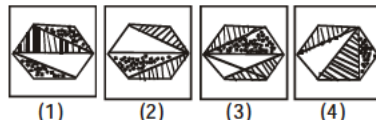

(SSC Combined Matric Level (PRE) Exam. 21.05.2000 (1st Sitting) (Raipur, Madhya Pradesh))

16. Which of the answer figures is exactly the mirror image of the given figure when the mirror is held at MN?

Question Figure :

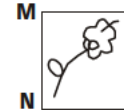

Answer Figures :

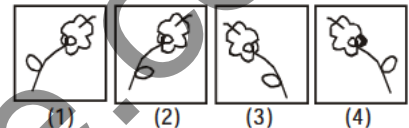

(SSC Combined Matric Level (PRE) Exam. 21.05.2000 (1st Sitting) (Raipur, Madhya Pradesh))

17. Which of the answer figures is exactly the mirror image of the given figure when the mirror is held at MN?

Question Figure :



Answer Figures :

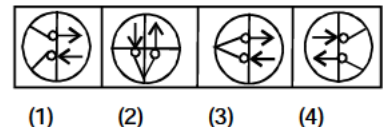

(SSC Combined Matric Level (PRE) Exam. 21.05.2000 (1st Sitting) (Middle Zone))

18. Which of the answer figures is exactly the mirror image of the given figure when the mirror is held at AB?

Question Figure :

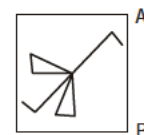

Answer Figures :

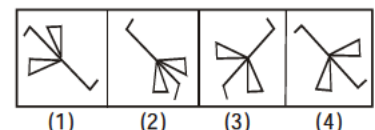

(SSC Combined Matric Level (PRE) Exam. 21.05.2000 (IInd Sitting) (Middle Zone, Allahabad))

MIRROR & WATER IMAGES

19. Which of the answer figures is exactly the mirror image of the given figure when the mirror is held at XY?

Question Figure :

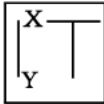

Answer Figures :



(1) (2) (3) (4)

(SSC Combined Matric Level (PRE)
Exam. 27.05.2001 (IInd Sitting)
(East Zone)

20. A clock with only dots marking 3, 6, 9 and 12 positions has been kept upside down in front of a mirror. In the reflection a time of 4.15 will look approximately like

(1) 2.15 (2) 8.45
(3) 8.50 (4) 9.45

(SSC Combined Matric Level (PRE)
Exam. 05.05.2002 (1st Sitting)
(Eastern Zone, Guwahati)

Direction (21) : In question nos. 24 and 25, which of the answer figures is exactly the mirror image of the question figure when the mirror is held at MN?

(SSC Combined Matric Level (PRE)
Exam. 05.05.2002 (1st Sitting)
(Eastern Zone, Guwahati)

21. **Question Figure :**



M — N

Answer Figures :

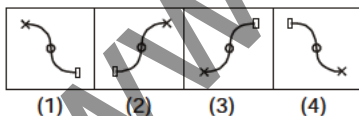

(1) (2) (3) (4)

22. **Question Figure :**

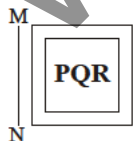

Answer Figures :



(1) (2) (3) (4)

(SSC Combined Matric Level (PRE)
Exam. 05.05.2002 (1st Sitting)
(Eastern Zone, Guwahati)

Directions (23-24) : Which of the answer figures is exactly the mirror image of the given figure when the mirror is held at AB?

(SSC Combined Matric Level (PRE)
Exam. 05.05.2002 (IInd Sitting)
(Eastern Zone, Guwahati)

23. **Question Figure :**



Answer Figures :

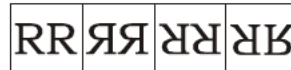

(1) (2) (3) (4)

24. **Question Figure :**

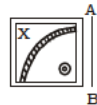

Answer Figures :



(1) (2) (3) (4)

Directions (25-26) : In each of the following questions which of the answer figures is exactly the mirror image of the question figure when the mirror is held at XY?

(SSC Combined Matric Level (PRE)
Exam. 05.05.2002 (1st Sitting)
(North Zone, Delhi)

25. **Question Figure :**

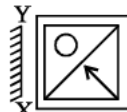

Answer Figures :

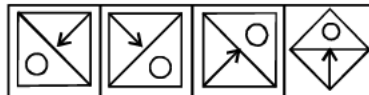

(1) (2) (3) (4)

26. **Question Figure :**



Answer Figures :



(1) (2) (3) (4)

Directions (27-28) : Which of the answer figures is exactly the mirror image of the given figure if the mirror is held at AB?

(SSC Combined Matric Level (Pre) Exam.
05.05.2002 (IInd Sitting)
(North Zone Delhi)

27. **Question Figure :**

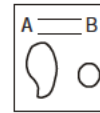

Answer Figures :



(1) (2) (3) (4)

28. **Question Figure :**



Answer Figures :

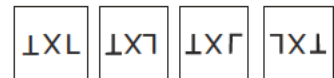

(1) (2) (3) (4)

29. Which of the Answer Figures is exactly the mirror image of the given problem figure when one mirror is held at, left side?



Answer Figures :



(1) (2) (3) (4)

(SSC Combined Matric Level (Pre)
Exam. 12.05.2002 (1st Sitting)

Question Figure :

30. Which one of the Answer Figures is exactly the mirror image of the given figure when the mirror is held at AB?

Question Figure :



Answer Figures :

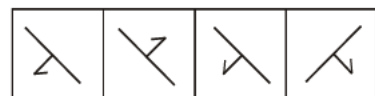

(1) (2) (3) (4)

(SSC Combined Matric Level (Pre)
Exam. 12.05.2002 (1st Sitting)

MIRROR & WATER IMAGES

Directions (31-32) : In each of the following questions which of the answer figures is exactly the mirror image of the given figure when the mirror is held at AB?

SSC Combined Matric Level (Pre)
Exam. 12.05.2002 (IIInd Sitting)

31. Question Figure :

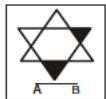

Answer Figures :

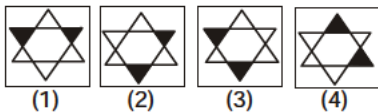

32. Question Figure :



Answer Figures :

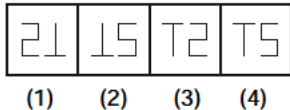

Directions (33-36) : Which of the answer figures is exactly the mirror image of the given figure when the mirror is held at PQ?

SSC Combined Matric Level (Pre)
Exam. 16.06.2002 (Re-Exam)

33. Question Figure :



Answer Figures :

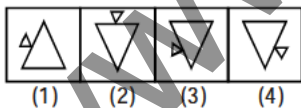

34. Question Figure :

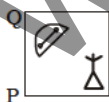

Answer Figures :

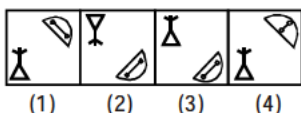

35. Question Figure :



Answer Figures :

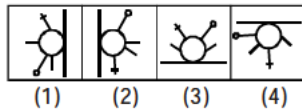

SSC Combined Matric Level (Pre)
Exam. 16.06.2002 (Re-Exam)

36. Question Figure :



Answer Figures :

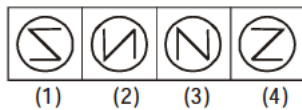

SSC Combined Matric Level (Pre)
Exam. 16.06.2002 (Re-Exam)

Directions (37-38) : Which of the answer figures is exactly the mirror image of the given figure when the mirror is held at AB?

SSC Combined Matric Level (Pre)
Exam. 30.07.2006 (1st Sitting)
(East Zone)

37. Question Figure :

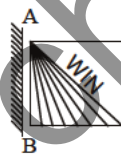

Answer Figures :

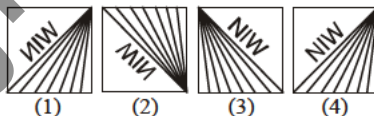

38. Question Figure :

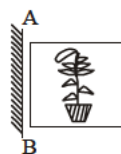

Answer Figures :

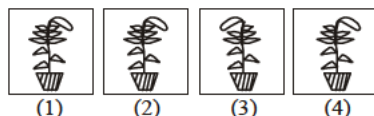

39. Which of the answer figures is exactly the mirror image of the given figure, when the mirror is held at AB?

Question Figure :

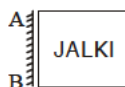

Answer Figures :

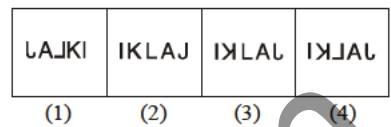

SSC Combined Matric Level (Pre) Exam.
30.07.2006 (IIInd Sitting) (Central Zone)

40. Choose the correct mirror image of the figure, when the mirror is held at AB :

Question Figure :



Answer Figures :

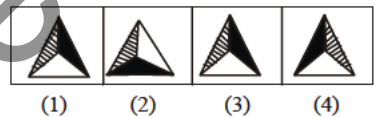

SSC Combined Matric Level (Pre) Exam.
30.07.2006 (IIInd Sitting) (Central Zone)

41. If a mirror is placed on the line LM, then which of the answer figures is the right image of the given question figure ?

Question Figure :

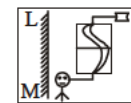

Answer Figures :

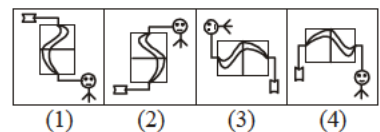

SSC Combined Matric Level (Pre)
Exam. 30.03.2008 (1st Sitting)

42. If a mirror is placed on the line MN, then which of the answer figures is the right image of the given question figure ?

Question Figure :

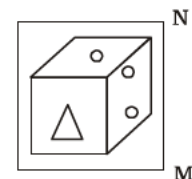

Answer Figures :

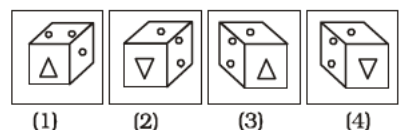

(SSC Higher Secondary Level Data Entry Operator & LDC Exam. 27.11.2010)

MIRROR & WATER IMAGES

43. If a mirror is placed on the line MN, then which of the answer figures is the right image of the given question figure ?

Question Figure :

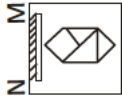

Answer Figures :

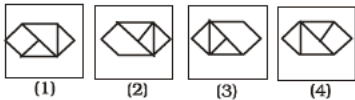

(SSC Higher Secondary Level Data Entry Operator & LDC Exam. 28.11.2010 (1st sitting))

44. If a mirror is placed on the line MN, then which of the answer figures is the correct image of the given question figure ?

Question Figure :

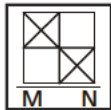

Answer Figures :

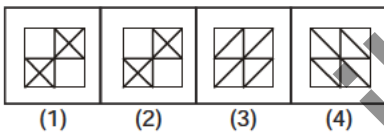

(SSC Higher Secondary Level Data Entry Operator & LDC Exam. 28.11.2010 (IInd sitting))

45. If a mirror is placed on the line LM, then which of the answer figures is the right image of the given question figure ?

Question Figure :



Answer Figures :

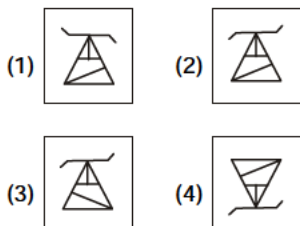

(SSC Stenographer Grade 'C' & 'D' Exam. 09.01.2011)

46. Which of the answer figures is exactly the mirror image of the given figure, when the mirror is held on the line AB ?

Question Figure :

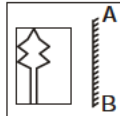

Answer figures :

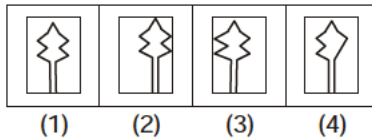

(SSC (10+2) Level Data Entry Operator & LDC Exam. 04.12.2011 (1st Sitting (North Zone)))

47. Which of the answer figures is exactly the mirror image of the question figure, when the mirror is held on the line PQ?

Question figure :

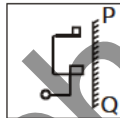

Answer figures :

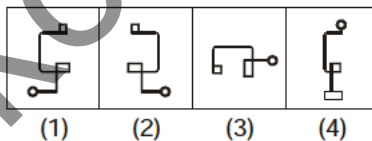

(SSC (10+2) Level Data Entry Operator & LDC Exam. 04.12.2011 (IInd Sitting (North Zone)))

48. Which of the answer figure is exactly the mirror image of the given figure, when the mirror is held on the line AB ?

Question Figure :

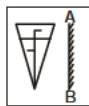

Answer Figures :

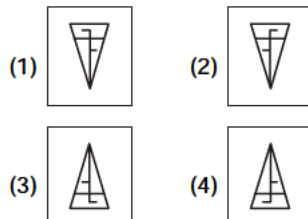

(SSC (10+2) Level Data Entry Operator & LDC Exam. 04.12.2011 (1st Sitting (East Zone)))

49. Which of the answer figures is exactly the mirror image of the question figure, when the mirror is held on the line AB?

Question Figure :

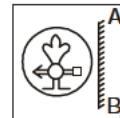

Answer Figures :

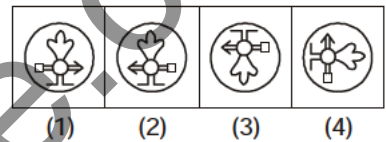

(SSC (10+2) Level Data Entry Operator & LDC Exam. 04.12.2011 (IInd Sitting (East Zone)))

50. Which of the answer figure is exactly the mirror image of the given figure, when the mirror is held on the line AB?

Question Figure :



Answer Figures :

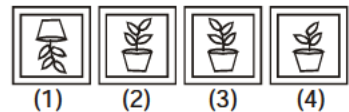

(SSC (10+2) Level Data Entry Operator & LDC Exam. 11.12.2011 (1st Sitting (Delhi Zone)))

51. Which of the answer figure is exactly the mirror image of the given figure, when the mirror is held on the line AB ?

Question Figure :



Answer Figures :

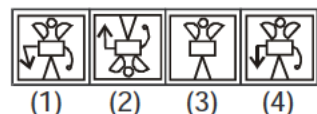

(SSC (10+2) Level Data Entry Operator & LDC Exam. 11.12.2011 (IInd Sitting (Delhi Zone)))

MIRROR & WATER IMAGES

52. Which of the answer figure is exactly the mirror image of the given figure, when the mirror is held on the line A B ?

Question Figure :



Answer Figures :

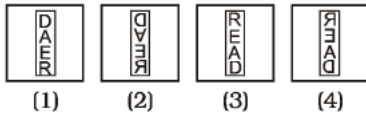

SSC (10+2) Level Data Entry Operator & LDC Exam. 11.12.2011 (1st Sitting (East Zone))

53. Which of the answer figure is exactly the mirror image of the given figure, when the mirror is held on the line A B ?

Question Figure :

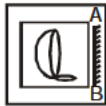

Answer Figures :

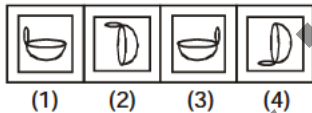

SSC (10+2) Level Data Entry Operator & LDC Exam. 11.12.2011 (IInd Sitting (East Zone))

54. Which of the answer figures is exactly the mirror image of the given figure, when the mirror is held on the line MN?

Question Figure :



Answer Figures :

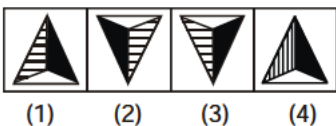

SSC Constable (GD) & Rifleman (GD) Exam. 22.04.1912 (1st Sitting)

55. Which of the answer figure is exactly the mirror image of the given figure, when the mirror is held on the line MN?

Question Figure :



Answer Figures :

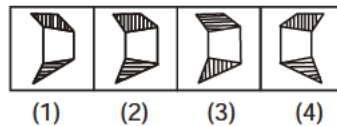

SSC Constable (GD) & Rifleman (GD) Exam. 22.04.1912 (IInd Sitting)

Directions (56-57) : In each of the following questions, if a mirror is placed on the line XY, then which of the answer figures is the correct image of the given question figure ?

(SSC Level Data Entry Operator & LDC Exam.21.10.2012 (1st Sitting))

56. **Question Figure :**



Answer Figures :

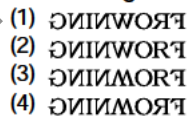

57. **Question Figure :**



Answer Figures :

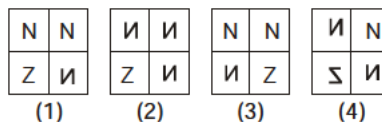

Directions (58-59) : In each of the following questions, if a mirror is placed on the line MN, then which of the answer figures is the right image of the given figure ?

(SSC Level Data Entry Operator & LDC Exam.21.10.2012 (IInd Sitting))



58. **WINCHESTER**

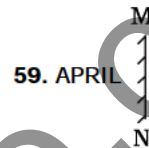
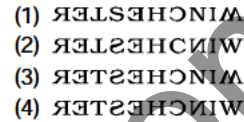

59. **APRIL**

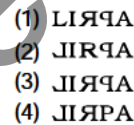

60. If a mirror is placed on the line MN, then which of the answer words is the right image of the given word ?

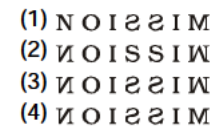

(SSC Level Data Entry Operator & LDC Exam.21.10.2012 (IInd Sitting))

Directions (61-62) : In each of the following questions, if a mirror is placed on the line xy, then which of the answer figures is the right image of the given figure ?

(SSC Level Data Entry Operator & LDC Exam.28.10.2012 (1st Sitting))

61. **Question Figure :**

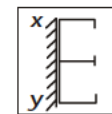

Answer Figures :

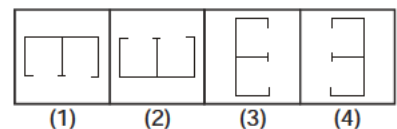

MIRROR & WATER IMAGES



- (1) REPTEMBERS
- (2) SEPTENBER
- (3) SEPTEMBER
- (4) SEPTEMBER

Directions (63-64) : In each of the following question, if a mirror is placed on the line MN, then which of the word is the right image of the given word ?

(SSC Level Data Entry Operator & LDC Exam.28.10.2012 (1st Sitting))

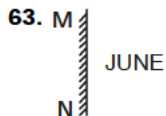

- (1) ENUL
- (2) JUNE
- (3) ENUL
- (4) JUNE

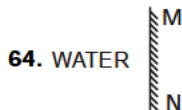

- (1) RETAW
- (2) RETAW
- (3) RETAW
- (4) RETAW

65. Find out the mirror image of the given figure :

Question Figure :



Answer Figures :

- (1)
- (2)
- (3)
- (4)

(SSC Level Data Entry Operator & LDC Exam.04.11.2012 (IInd Sitting))

66. Which of the answer figures is the mirror image of the given figure if the mirror is held at AB ?

Question Figure :



Answer Figures :

- (1)
- (2)
- (3)
- (4)

(SSC Graduate Level Tier-I Exam.11.11.2012 (1st Sitting))

67. Which of the answer figure is exactly the mirror image of the given figure, when the mirror is held on the line AB ?

Question Figure :



Answer Figures :

- (1)
- (2)
- (3)
- (4)

FCI Assistant Grade-III Exam. 25.02.2012 (Paper-I) North Zone (1st Sitting)

68. Which of the answer figures is exactly the mirror image of the given figure, when the mirror is held on the line A B ?

Question Figure :

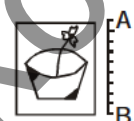

Answer Figures :

- (1)
- (2)
- (3)
- (4)

FCI Assistant Grade-III Exam. 05.02.2012 (Paper-I) East Zone (IInd Sitting)

69. Find out the mirror image of the given figure.

Question Figure :



Answer Figures :

- (1)
- (2)
- (3)
- (4)

(SSC (10+2) Level Data Entry Operator & LDC Exam. 04.11.2012, 1st Sitting)

70. If a mirror is placed on the line x, then which of the answer figures is the right image of the given figure?

Question Figure :

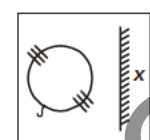

Answer Figures :

- (1)
- (2)
- (3)
- (4)

(SSC Multi-Tasking Staff Exam. 10.03.2013, 1st Sitting : Patna)

71. Which is the mirror image of the question figure when the mirror is held at X ?

Question Figure :



Answer Figures :

- (1)
- (2)
- (3)
- (4)

(SSC Multi-Tasking Staff Exam. 10.03.2013)

72. If a mirror is placed on the line MN, then which of the answer figures is the right image of the given figure ?

Question Figure :

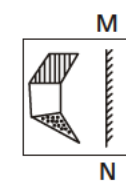

Answer Figures :

- (1)
- (2)
- (3)
- (4)

(SSC Multi-Tasking Staff Exam. 17.03.2013, Kolkata Region)

MIRROR & WATER IMAGES

73. Which of the answer figures is the right mirror image of the question figure ?

Question Figure :

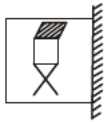

Answer Figures :

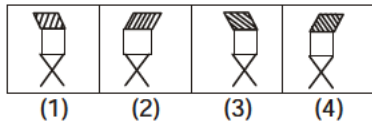

(SSC Multi-Tasking Staff Exam. 17.03.2013, 1st Sitting)

Directions (74-75) : In the following questions, a mirror is placed on line MN. Then which of the answer figures is the correct image of the given figure ?

(SSC Multi-Tasking Staff Exam. 17.03.2013, IIInd Sitting)

74. **Question Figure :**



Answer Figures :

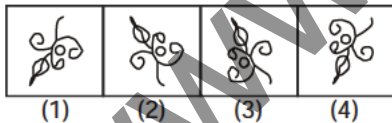

75. **Question Figure :**



Answer Figures :

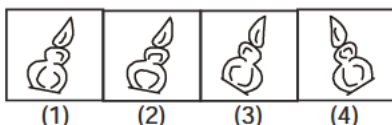

Directions (76-77) : In each of the following questions, if a mirror is placed on the line MN, then which of the answer figures is the right image of the given figure?

(SSC Multi-Tasking Staff Exam. 24.03.2013, 1st Sitting)

76. **Question Figure :**

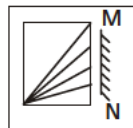

Answer Figures :

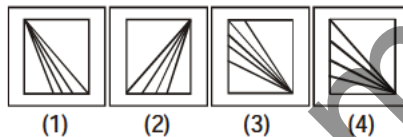

77. **Question Figure :**

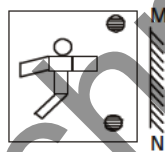

Answer Figures :

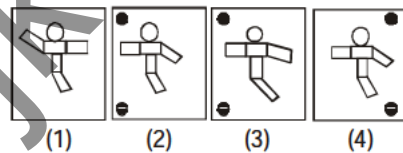

78. If a mirror is placed on the line XY then which of the answer figures is the right image of the given figure ?

Question Figure :

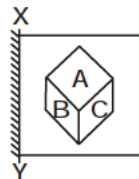

Answer Figures :

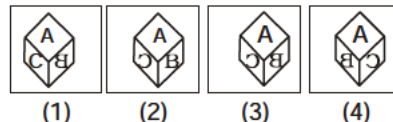

(SSC Graduate Level Tier-I Exam. 21.04.2013, 1st Sitting)

79. If a mirror is placed on the line MN, then which of the answer figures is the right image of the given figure ?

Question Figure :

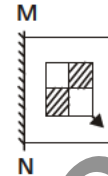

Answer Figures :

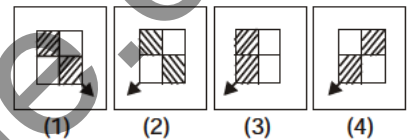

(SSC Graduate Level Tier-I Exam. 21.04.2013, 1st Sitting)

80. From the answer figures, find out the figure which is the exact mirror image of the question figure, when the mirror is placed on the line 'MN' ?

Question Figure :

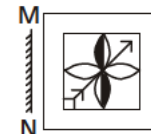

Answer Figures :

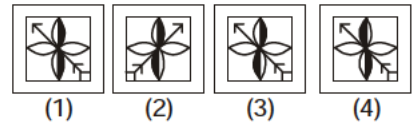

(SSC Graduate Level Tier-I Exam. 21.04.2013, IIInd Sitting)

81. Which of the answer figures is exactly the mirror image of the given pattern of numbers when the mirror is held at MN ?

Question Figure :

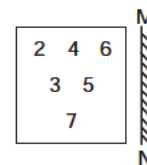

Answer Figures :

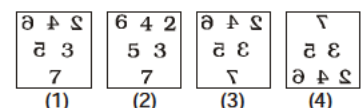

(SSC Graduate Level Tier-I Exam. 21.04.2013, IIInd Sitting)

MIRROR & WATER IMAGES

82. Which of the answer figures is the right mirror image of the given figure ?

PRAYER

- (1) P R A Y E R
- (2) R E P R A Y
- (3) R E Y A R P
- (4) R P R A Y E R

(SSC Constable (GD) Exam. 12.05.2013)

83. If a mirror is placed on the line MN, then which of the answer figures is the right image of the given figure ?

Question Figure :

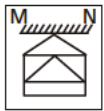

Answer Figures :

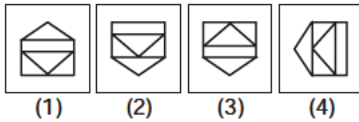

(SSC Constable (GD) Exam. 12.05.2013 1st Sitting)

84. From the answer figures, find out the figure which is the exact mirror image of the question figure, when the mirror is placed on the line 'MN'.

Question Figure :

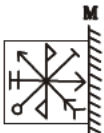

Answer Figures :

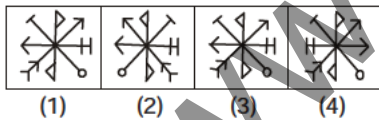

(SSC Graduate Level Tier-I Exam. 19.05.2013, 1st Sitting)

85. From the answer figures, find out the figure which is the exact mirror image of the question figure, when the mirror is placed on the line MN.

Question Figure :



Answer Figures :

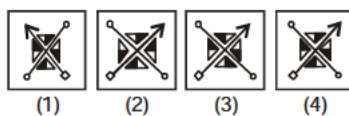

(SSC Graduate Level Tier-I Exam. 19.05.2013, IIInd Sitting)

Directions (86-87) : In each of the following questions, if a mirror is placed on the line AB, then which of the answer figures is the right image of the given figure?

(SSC CAPFs SI & CISF ASI Exam. 23.06.2013)

86. Question Figure :



Answer Figures :

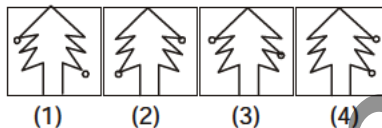

87. Question Figure :

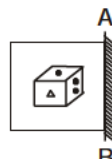

Answer Figures :

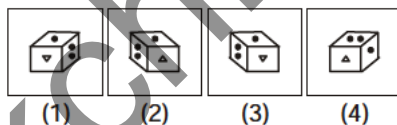

88. Which of the answer figure is exactly the mirror image of the given figure ?

Question Figure :

MOVE

Answer Figures :

- (1) MOVE EVOM
- (2) MOVE EVOM
- (3) MOVE EVOM
- (4) MOVE EVOM

(SSC Cabinet Secretariat RO (ECO), DFO (T) & DFO (GD) Tier-I Exam. 23.06.2013)

89. If a mirror is placed on the line MN, then which of the answer figures is the right image of the given figure ?

Question Figure :

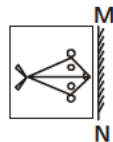

Answer Figures :

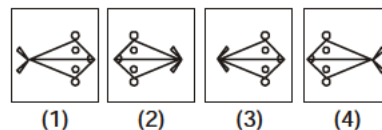

(SSC Multi-Tasking (Non-Tech.) Staff Exam. 16.02.2014)

90. If a mirror is placed on the line MN, then which of the answer figures is the right image of the given figure ?

Question Figure :

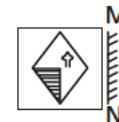

Answer Figures :

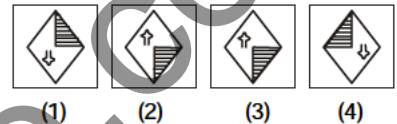

(SSC Multi-Tasking Staff (Patna) Exam. 16.02.2014)

91. If a mirror is placed on the line MN, then which of the answer figures is the right image of the given figure ?

Question Figure :

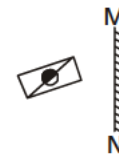

Answer Figures :

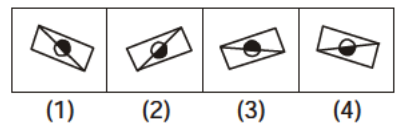

(SSC Multi-Tasking (Non-Tech.) Staff Exam. 23.02.2014, IIInd Sitting)

92. If a mirror is placed on the line MN, then which of the answer figures is the right image of the given figure ?

Question Figure :

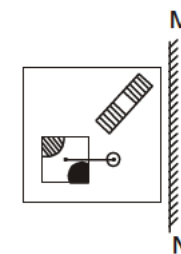

Answer Figures :

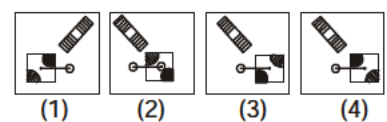

(SSC CGL Tier-I Re-Exam-2013, 27.04.2014)

MIRROR & WATER IMAGES

93. If a mirror is placed on the line MN, then which of the answer figures is the right image of the given figure ?

Question Figure :



Answer Figures :



(1) (2) (3) (4)

(SSC CAPFs SI, CISF ASI & Delhi Police SI Exam. 22.06.2014)

94. If a mirror is placed on the line MN, then which of the answer figures is the right image of the given figure ?

Question Figure :



Answer Figures :



(1) (2) (3) (4)

(SSC CAPFs SI, CISF ASI & Delhi Police SI Exam. 22.06.2014)

95. If a mirror is placed on the line MN, then which of the answer figures is the right image of the given figure ?

Question Figure :

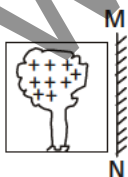

Answer Figures :

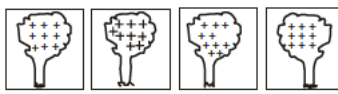

(1) (2) (3) (4)

(SSC GL Tier-I Re-Exam. (2013) 20.07.2014, 1st Sitting)

96. If a mirror is placed on the line MN, then which of the answer figures is the correct image of the question figure ?

Question Figure :

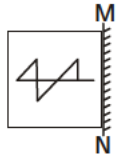

Answer Figures :

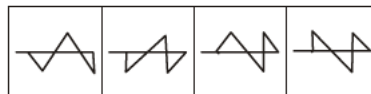

(1) (2) (3) (4)

(SSC GL Tier-I Re-Exam. (2013) 20.07.2014, IIInd Sitting)

97. If a mirror is placed on the line MN, then which of the answer figures is the right image of the given figure ?

Question Figure :



Answer Figures :

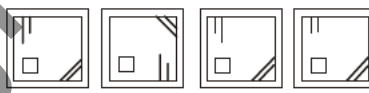

(1) (2) (3) (4)

(SSC GL Tier-I Exam. 19.10.2014, 1st Sitting & Bihar SSC 2nd CGL (Pre) Exam. 23.02.2015)

98. Which of the answer figure is exactly mirror image of the given figure when the mirror is held at XY ?

Question Figure :

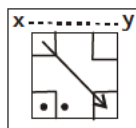

Answer Figures :

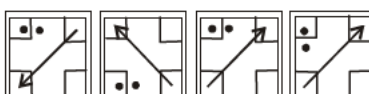

(1) (2) (3) (4)

(SSC GL Tier-I Exam. 19.10.2014)

99. If a mirror is placed on the line MN, then which of the answer figures is the right image of the given question figure ?

Question Figure :

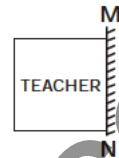

Answers Figures :



(1) (2) (3) (4)

(SSC GL Tier-I Exam. 26.10.2014)

100. Which of the answer figures is exactly mirror image of given figure ?

Question Figure :

6 5 4

Answer Figures :

957 428 456 654

(1) (2) (3) (4)

(SSC CHSL (10+2) DEO & LDC Exam. 02.11.2014, Patna Region : 1st Sitting)

101. Choose the alternative which most closely resembles the mirror-image of the given combination.

DANIEL

(1) DANIEL (2) DANIEL

(3) DANIEL (4) DANIEL

(SSC CHSL (10+2) DEO & LDC Exam. 02.11.2014, IIInd Sitting)

102. If a mirror is placed on the line MN, then which of the answer figures is the right image of the given figure ?

Question Figure :

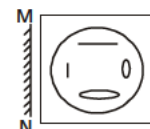

Answer Figures :

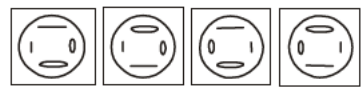

(1) (2) (3) (4)

(SSC CHSL (10+2) DEO & LDC Exam. 09.11.2014)

MIRROR & WATER IMAGES

103. Identify the alternative which resembles the mirror-image of the given word.

DL9Q3574

- (1) 4733Q9LD
- (2) 4733Q9LD
- (3) 4753Q9LD
- (4) 4733Q9LD

(SSC CHSL (10+2) DEO & LDC Exam. 16.11.2014, Patna Region : 1st Sitting)

104. Identify the alternative which resembles the mirror-image of the given word.

SECRETARY

- (1) YRATERCY
- (2) YRATERCY
- (3) YRATERCY
- (4) YRATERCY

(SSC CHSL (10+2) DEO & LDC Exam. 16.11.2014)

105. If a mirror is placed on the line MN, then which of the answer figures is the right image of the given figure ?

Question Figure :

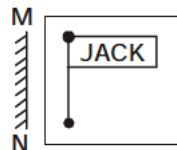

Answer Figures :

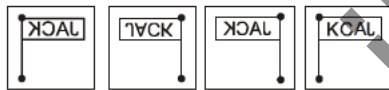

(SSC CGL Tier-I Exam. 19.10.2014 TF No. 022 MH 3)

106. If a mirror is placed on the line MN, then which of the answer figures is the right image of the given question figure

Question Figure :

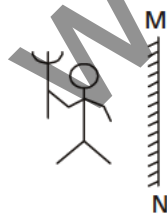

Answer Figures :



(1) (2) (3) (4)
(SSC CHSL (10+2) DEO & LDC Exam. 16.11.2014, 1st Sitting TF No. 333 LO 2)

107. Identify the alternative which resembles the mirror-image of the given word.

ENDURANCE

- (1) ENDURANCE
- (2) ENDURANCE
- (3) ENDURANCE
- (4) ENDURANCE

(SSC CHSL (10+2) DEO & LDC Exam. 16.11.2014, 1st Sitting TF No. 545 QP 6)

108. Which is the correct image if the picture is held in front of a mirror ?

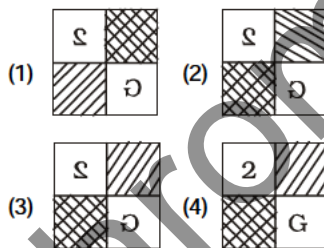
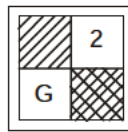

(SSC CAPFs SI, CISF ASI & Delhi Police SI Exam, 21.06.2015 (1st Sitting) TF No. 8037731)

109. If a mirror is placed on the line MN, then which of the answer figures is the right image of the given figure.

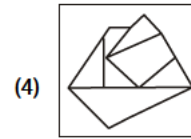
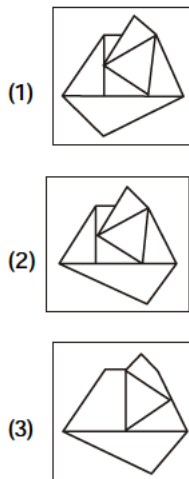
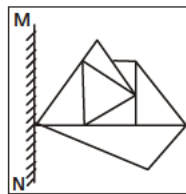

(4)

(SSC CAPFs SI, CISF ASI & Delhi Police SI Exam, 21.06.2015 (1st Sitting) TF No. 8037731)

Directions (110-111) : In each of the following questions, if a mirror is placed on the line MN, then which of the answer figures is the right image of the given figure ?

(SSC CAPFs SI, CISF ASI & Delhi Police SI Exam, 21.06.2015 1st Sitting)

110. Question Figure :

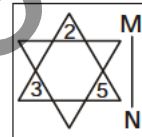

Answer Figures :

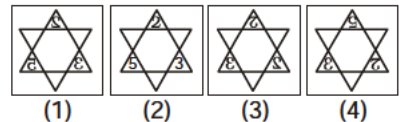

111. Question Figure :



Answer Figures :

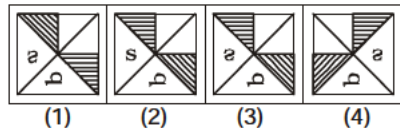

112. If a mirror is placed on the line MN, then which of the answer figures is the right image of the given figure?

Question Figure :



Answer Figures :

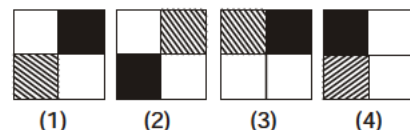

(SSC CGL Tier-I Exam, 09.08.2015 (1st Sitting) TF No. 1443088)

MIRROR & WATER IMAGES

113. If a mirror is placed on the line MN, which of the answer figures is the right image of the given figure ?

Question Figure :



Answer Figures :



(1) (2) (3) (4)

(SSC CGL Tier-I Exam, 09.08.2015 (IInd Sitting) TF No. 4239378)

114. If a mirror is placed on the line MN, then which of the answer figures is the right image of the given figure?

Question Figure :

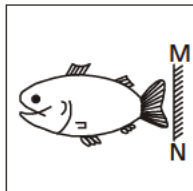

Answer Figures :

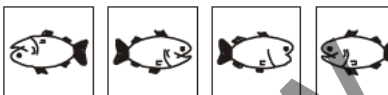

(1) (2) (3) (4)

(SSC CGL Tier-I Exam, 16.08.2015 (1st Sitting) TF No. 3196279)

115. If a mirror is placed on the line MN, then which of the answer figures is the right image of the given figure?

Question Figure :



Answer Figures :



(1) (2) (3) (4)

(SSC CGL Tier-I Exam, 16.08.2015 (IInd Sitting) TF No. 2176783)

116. If a mirror is placed on the line MN, then which of the answer figures is the right image of the given figure?

Question Figure :

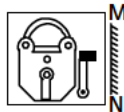

Answer Figures :

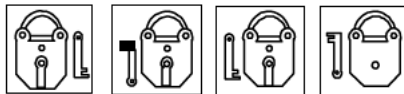

(1) (2) (3) (4) (5)

(SSC CGL Tier-I Re-Exam, 30.08.2015)

117. Which of the answer figure is exactly the mirror image of the given figure ?

Question Figure :

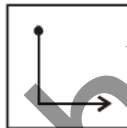

Answer Figures :



(1) (2) (3) (4)

(SSC Constable (GD) Exam, 04.10.2015, 1st Sitting)

118. In the question, if a mirror is placed on the line AB then which of the answer figures is the right image of the given figure ?

Question Figure :

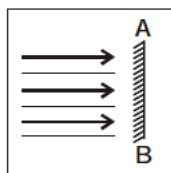

Answer Figures :

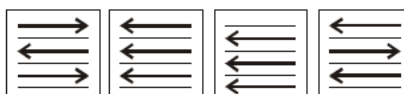

(1) (2) (3) (4)

(SSC Constable (GD) Exam, 04.10.2015, IInd Sitting)

119. If a mirror is placed on the line MN, then which of the answer figures is the right image of the given figure?

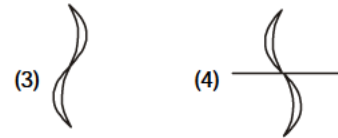
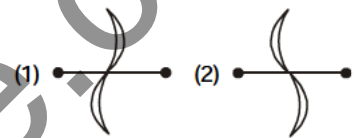
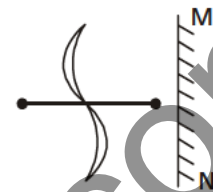

(SSC (10+2) LDC/DEO/PA/SA Exam, 01.11.2015 TF No. 1098066)

120. If a mirror is placed on the line RS, then which of the answer figures is the right image of the given figure?

Question Figure :

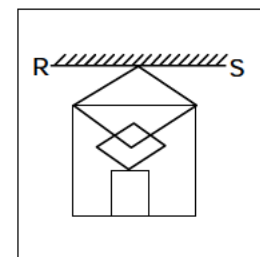

Answer Figures :

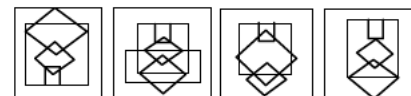

(1) (2) (3) (4)

(SSC CHSL (10+2) LDC, DEO & PA/SA Exam, 01.11.2015, IInd Sitting)

121. The image of a clock in a mirror is seen as 3.15. What is the right time?

(1) 8.45 (2) 10.45
(3) 7.45 (4) 9.45

(SSC CHSL (10+2) LDC, DEO & PA/SA Exam, 15.11.2015 (IInd Sitting) TF No. 7203752)

MIRROR & WATER IMAGES

122. If a mirror is placed on the line AB, then which of the answer figures is the right image of the given figure ?

Question Figure :

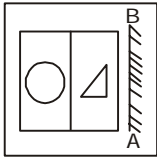

Answer Figures :

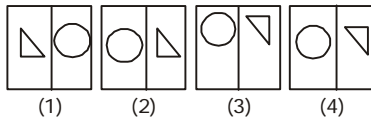

(SSC CHSL (10+2) LDC, DEO & PA/SA Exam, 06.12.2015 (1st Sitting) TF No. 1375232)

123. If a mirror is placed on the line MN, then which of the answer figures is the right image of the given figure?

Question Figure :

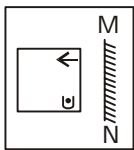

Answer Figures :

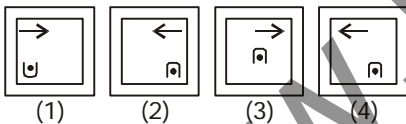

(SSC CHSL (10+2) LDC, DEO & PA/SA Exam, 20.12.2015 (1st Sitting) TF No. 9692918)

124. If a mirror is placed on the line MN, then which of the answer figures is the right image of the given figure?

Question Figure :

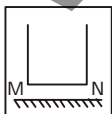

Answer Figures :

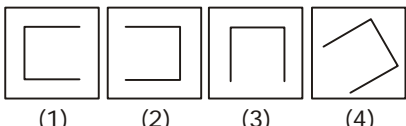

(SSC (10+2) Stenographer Grade 'C' & 'D' Exam. 31.01.2016 TF No. 3513283)

125. If a mirror is placed on the line MN, then which of the answer figures is the right image of the question figure?

Question Figure :

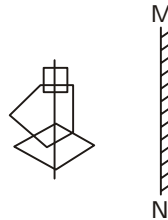

Answer Figures :

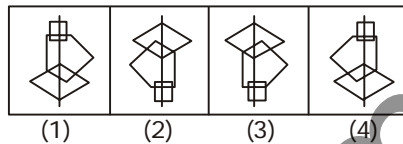

(SSC (10+2) Stenographer Grade 'C' & 'D' Exam. 31.07.2016)

126. If a mirror is placed on the line MN, then which of the answer figures is the right image of the given figure?

Question Figure :

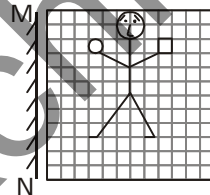

Answer Figures :

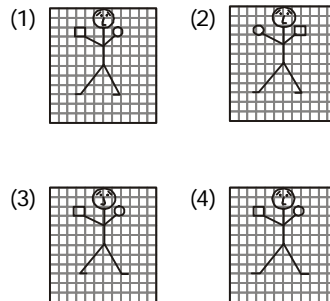

(SSC CGL Tier-I (CBE) Exam.10.09.2016)

127. If a mirror is placed on the line MN, then which of the answer figures is the right image of the given figure?

Question Figure :

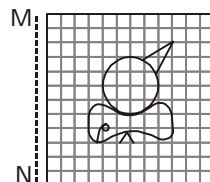

Answer Figures

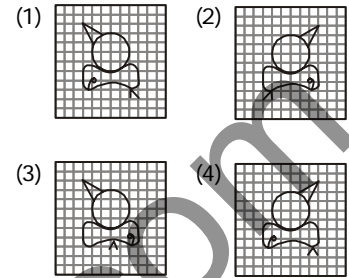

(SSC CGL Tier-I (CBE) Exam.11.09.2016) (1st Sitting)

128. In the following question, choose the correct mirror image from amongst the four alternatives A), B), C) and D) given along with it. The mirror may be represented by a line XY.

Question Figure :

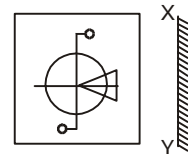

Answer Figures :

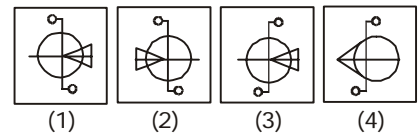

(SSC CPO SI, ASI Online Exam.05.06.2016) (1st Sitting)

129. In the following question, choose the correct mirror image from amongst the four alternatives A), B), C) and D) given along with it. The mirror may be represented by a line XY.

Question Figure :

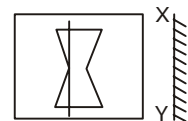

Answer Figures :

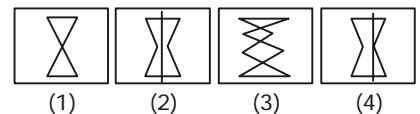

(SSC CPO SI, ASI Online Exam.05.06.2016) (1st Sitting)

MIRROR & WATER IMAGES

130. In the following question, choose the correct mirror-image from amongst the four alternatives (1), (2), (3) and (4) given along with it. The mirror may be represented by a line MN.

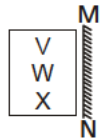

Answer Figures

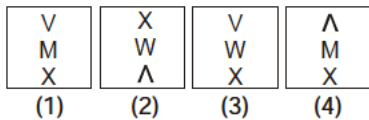

(SSC CPO Exam. 06.06.2016)
(1st Sitting)

131. In the following question, choose the correct mirror-image from amongst the four alternatives (1), (2), (3) and (4) given along with it. The mirror may be represented by a line MN.

M //////////////// N

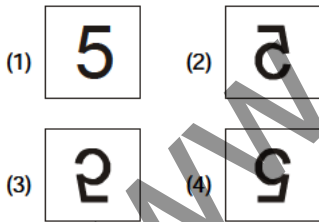

(SSC CPO Exam. 06.06.2016)
(1st Sitting)

132. Mirror is placed on the line MN, then which of the answer figures is the right mirror image?

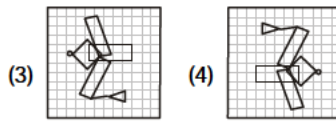
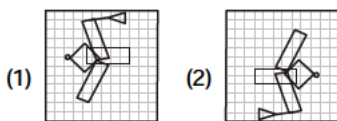
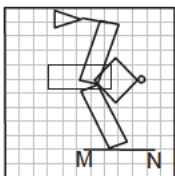

(SSC CHSL (10+2) Tier-I (CBE)
Exam. 08.09.2016) (1st Sitting)

133. Which of the answer figure is exactly the mirror image of the given figure, when the mirror is held on the line AB?

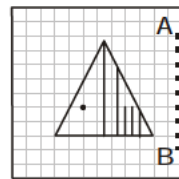

Answer Figures :

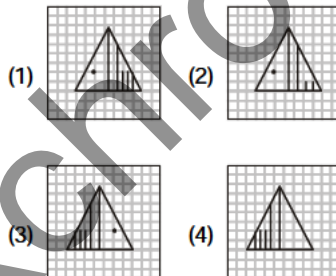

(SSC CGL Tier-I (CBE)
Exam. 09.09.2016) (1st Sitting)

Directions (134-135) : In each of the following questions, if a mirror is placed on the line MN, then which of the answer figures is the right image of the given figure?

(SSC CAPFs (CPO) SI & ASI, Delhi Police
Exam. 20.03.2016) (IInd Sitting)

134. **Given Figure :**

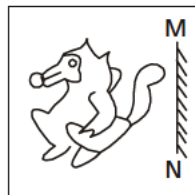

Answer Figures :

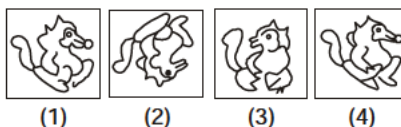

135. **Given Figure**

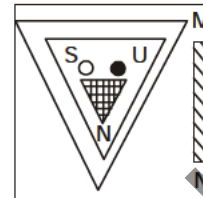

Answer Figures :



136. In the following question, a mirror is placed on the line MN, then which of the answers figures is the right image of the given figure?

Question Figure :

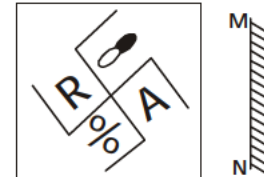

Answer Figures :

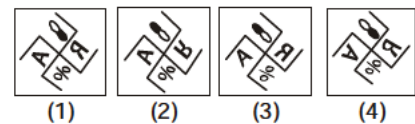

(SSC CAPFs (CPO) SI & ASI, Delhi Police
Exam. 05.06.2016) (1st Sitting)

137. In the following question, a mirror is placed on the line MN, then which of the answer figures is the right image of the given figure?

Question Figure :

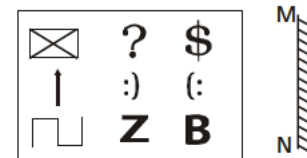

Answer Figures :

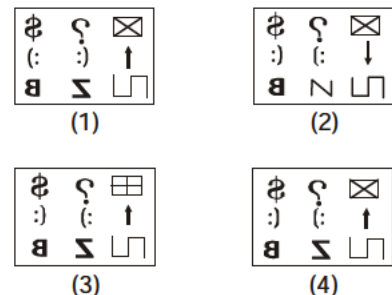

(SSC CAPFs (CPO) SI & ASI, Delhi Police
Exam. 05.06.2016) (1st Sitting)

MIRROR & WATER IMAGES

138. Observe the figures and find a mirror image of the same from the alternatives given. Imagine that MN is a mirror.

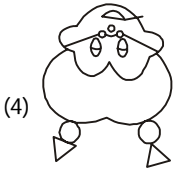
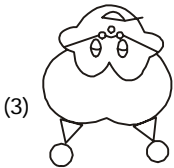
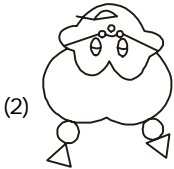
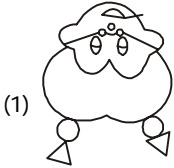
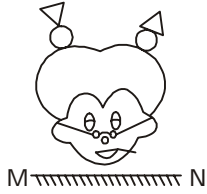

(SSC CPO SI & ASI, Online Exam. 06.06.2016) (IInd Sitting)

139. Observe the figures and find a mirror image of the same from the alternatives given. Imagine that MN is a mirror.

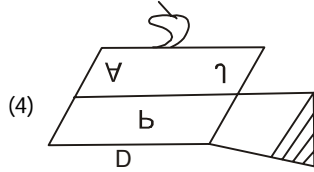
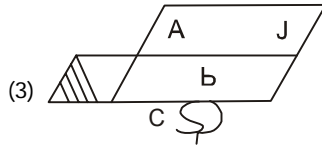
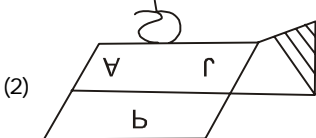
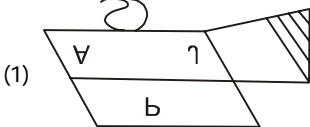
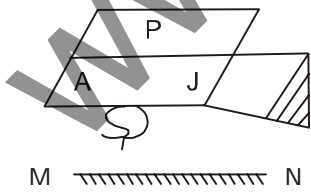

(SSC CPO SI & ASI, Online Exam. 06.06.2016) (IInd Sitting)

140. If a mirror is placed on the line MN, then which of the answer figures is the right image of the given figure?

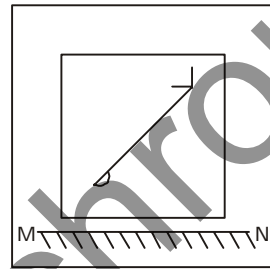

Answer Figures :

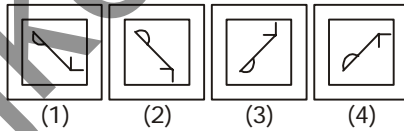

(SSC CGL Tier-I (CBE) Exam. 27.08.2016) (Ist Sitting)

141. What is the mirror image of the following figure? The mirror may be represented by a line XY.

Question Figure :

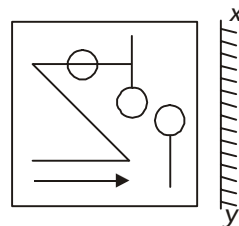

Answer Figures :

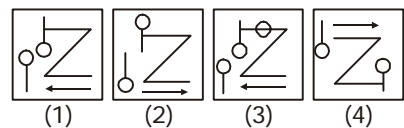

(SSC CGL Tier-I (CBE) Exam. 27.08.2016) (IInd Sitting)

142. If a mirror is placed on the line MN, then which of the answer figures is the right image of the given figure ?

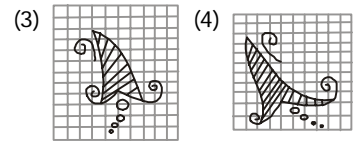
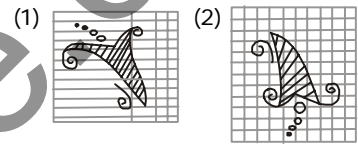
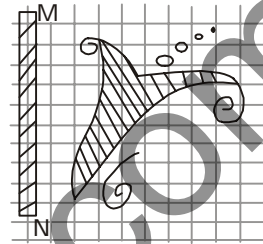

(SSC CGL Tier-I (CBE) Exam. 28.08.2016) (IInd Sitting)

143. If a mirror is placed on the line MN, then which of the answer figures is the right image of the given figure ?

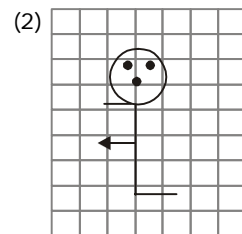
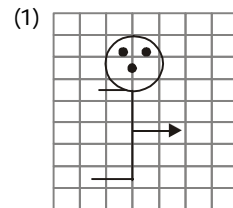
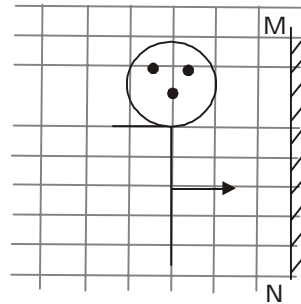

MIRROR & WATER IMAGES

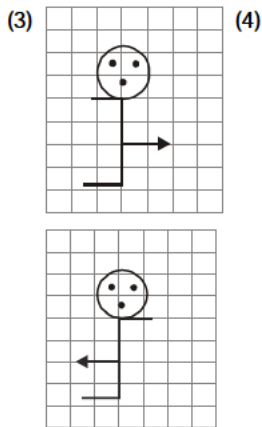

(SSC CGL Tier-I (CBE)
Exam. 29.08.2016) (IInd Sitting)

144. If a mirror is placed on the line MN, then which of the answer figures is the right image of the given figure ?

Question Figure :

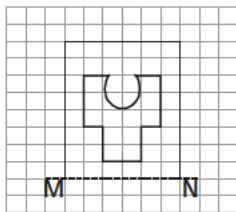

Answer Figures :

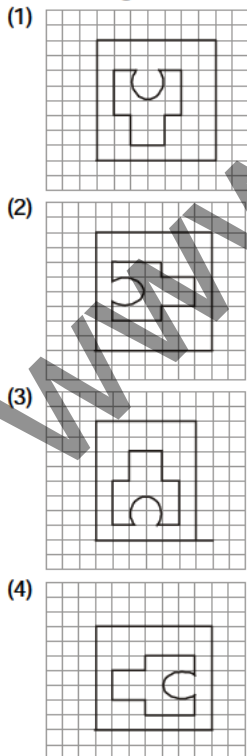

(SSC CGL Tier-I (CBE)
Exam. 30.08.2016) (1st Sitting)

145. If a mirror is placed on the line MN, then which of the answer figures is the right image of the given figure?

Question Figure :

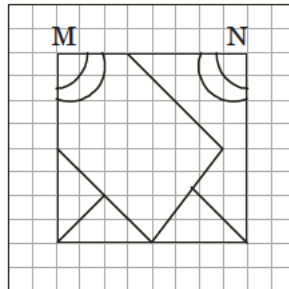

Answer Figures :

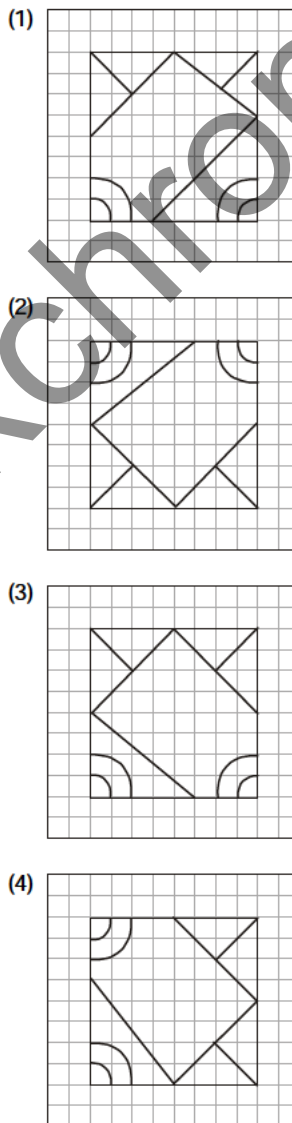

(SSC CGL Tier-I (CBE)
Exam. 31.08.2016) (1st Sitting)

146. If a mirror is placed on the line AB, then which of the answer figures is the right image of the given figure ?

Question Figure

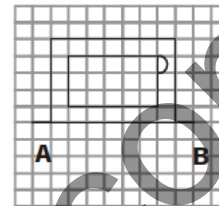

Answer Figures

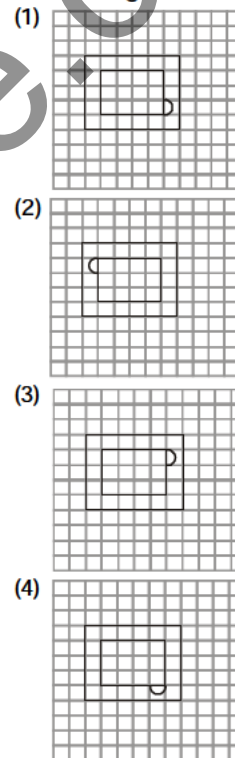

(SSC CGL Tier-I (CBE)
Exam. 01.09.2016) (1st Sitting)

147. If a mirror is placed on the line MN, then which of the answer figures is the right image of the given figure?

Question Figure :

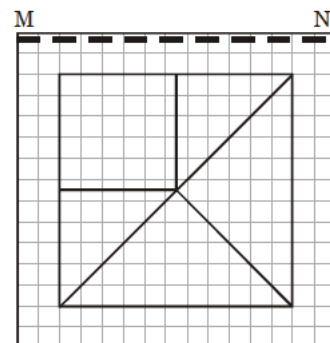

MIRROR & WATER IMAGES

Answer Figures :

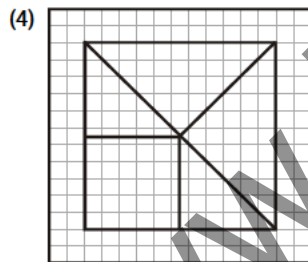
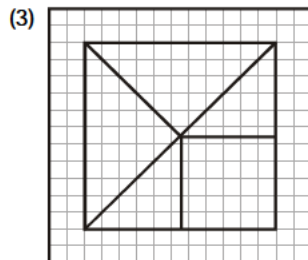
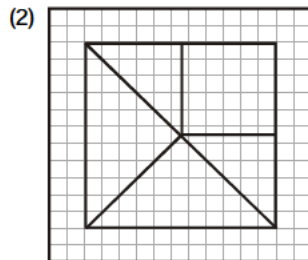
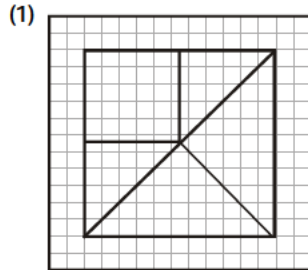

(SSC CGL Tier-I (CBE) Exam. 02.09.2016) (1st Sitting)

148. What is the mirror image of the following figure? Line AB represents the mirror.

Question Figure

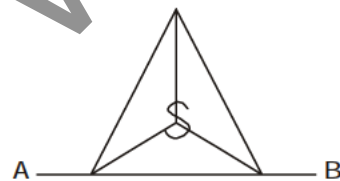

Answer Figures

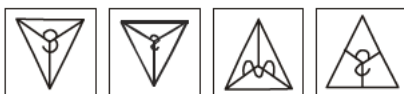

(1) (2) (3) (4)
(SSC CGL Tier-I (CBE) Exam. 02.09.2016) (IInd Sitting)

149. If a mirror is placed on the line MN, then which of the answer figures is the right image of the given figure?

Question Figure :

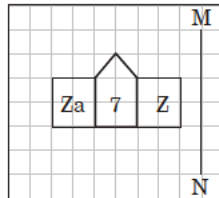

Answer Figures :

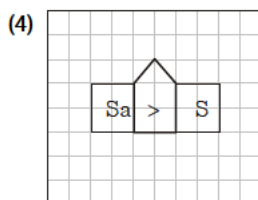
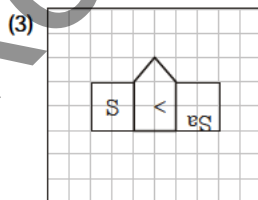
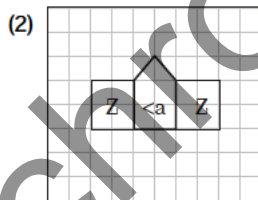
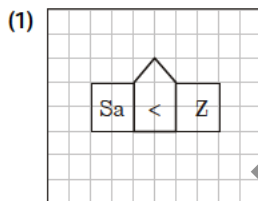

(SSC CGL Tier-I (CBE) Exam. 03.09.2016) (IInd Sitting)

150. The mirror image of a word is seen as given below. What is the actual word?

Question Figure :



Answer Figures :

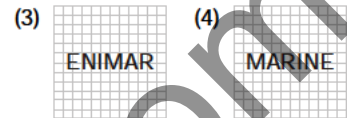
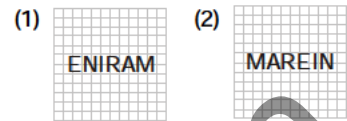

(SSC CGL Tier-I (CBE) Exam. 04.09.2016) (1st Sitting)

151. If a mirror is placed on the line MN, then which of the answer figures is the right image of the given figure?

Question Figure :

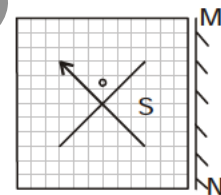

Answer Figures :

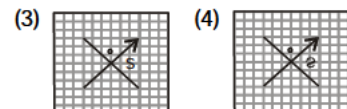
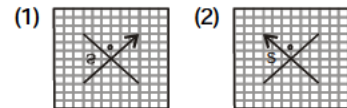

(SSC CGL Tier-I (CBE) Exam. 06.09.2016) (1st Sitting)

152. If a mirror is placed on the line MN, then which of the answer figures is the right image of the given figure?

Question Figure

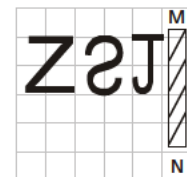

Answer Figures

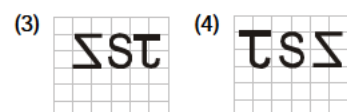
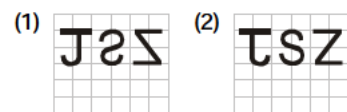

(SSC CGL Tier-I (CBE) Exam. 07.09.2016) (1st Sitting)

MIRROR & WATER IMAGES

153. If a mirror is placed on the line MN, then which of the answer figures is the right image of the given figure?

Question Figure :

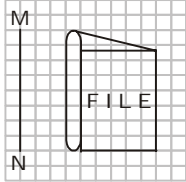

Answer Figures :

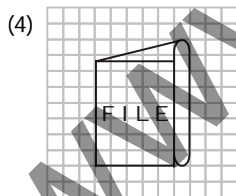
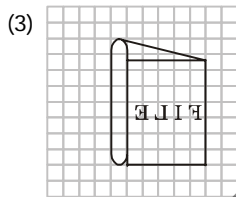
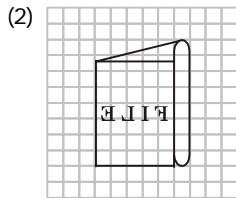
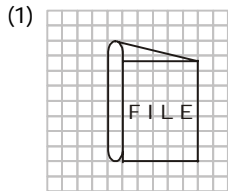

(SSC CGL Tier-I (CBE) Exam. 30.08.2016) (IInd Sitting)

154. If a mirror is placed on the line MN, then which of the answer figures is the right image of the given figure?

Question Figure :

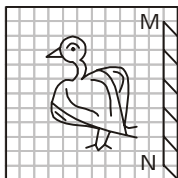

Answer Figures :

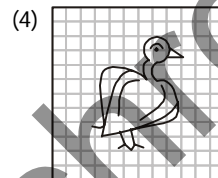
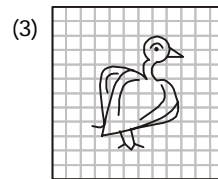
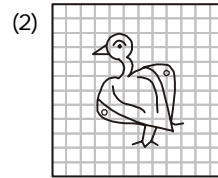
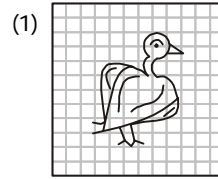

(SSC CGL Tier-I (CBE) Exam. 31.08.2016) (IInd Sitting)

155. If a mirror is placed on the line MN, then which of the answer figures is the right image of the given figure?

Question Figure :

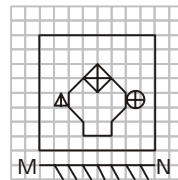

Answer Figures :

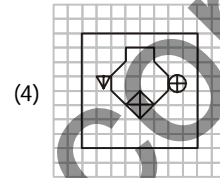
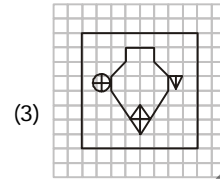
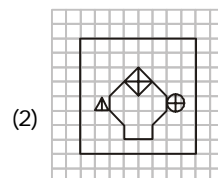
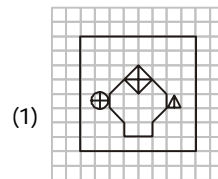

(SSC CGL Tier-I (CBE) Exam. 01.09.2016) (1st Sitting)

156. If a mirror is placed on the line MN, then which of the answer figures is the right image of the given figure?

Question Figure :

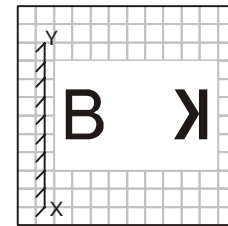

Answer Figures :

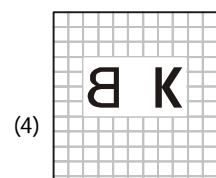
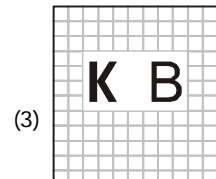
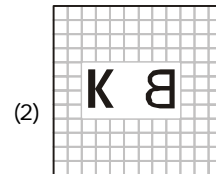
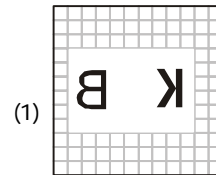

(SSC CGL Tier-I (CBE) Exam. 02.09.2016) (1st Sitting)

MIRROR & WATER IMAGES

157. If a mirror is placed on the line MN, then which of the answer figures is the right image of the given figure?

Question Figure :

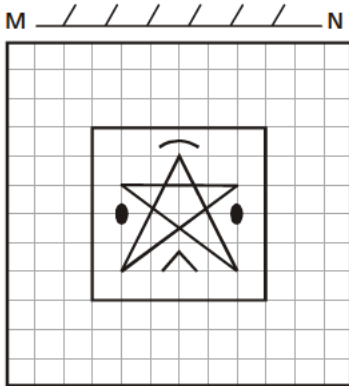

Answer Figures :

- (1)
- (2)
- (3)
- (4)

158. If a mirror is placed on the line MN, then which of the answer figures is the right image of the given figure?

Question Figure :

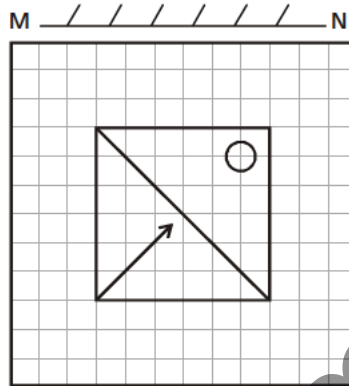

Answer Figures :

- (1)
- (2)
- (3)
- (4)

159. If a mirror is placed on the line MN, then which of the answer figures is the right image of the given figure?

Question Figure :

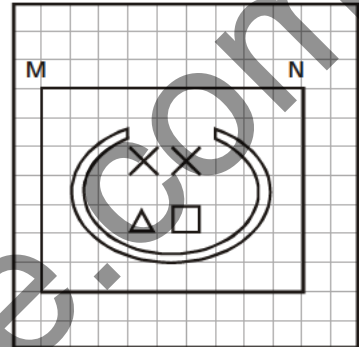

Answer Figures :

- (1)
- (2)
- (3)
- (4)

MIRROR & WATER IMAGES

160. If a mirror is placed on the line MN, then which of the answer figures is the right image of the given figure?

Question Figure :

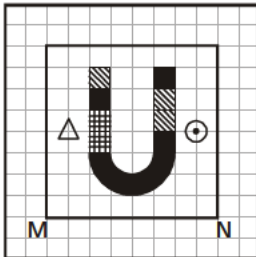

Answer Figures :

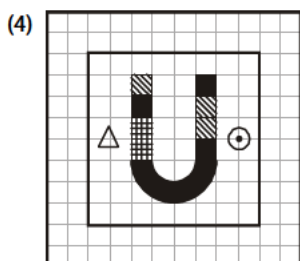
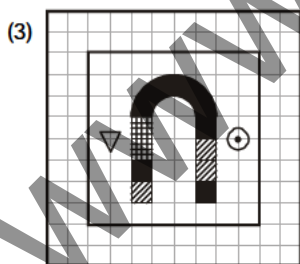
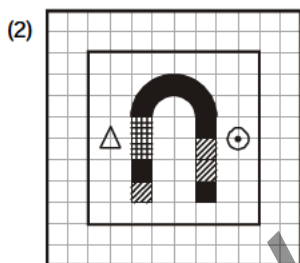
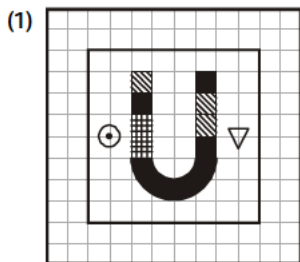

(SSC CGL Tier-I (CBE)
Exam. 31.08.2016) (IInd Sitting)

161. If a mirror is placed on the line MN, then which of the answer figures is the right image of the given figure?

Question Figure :

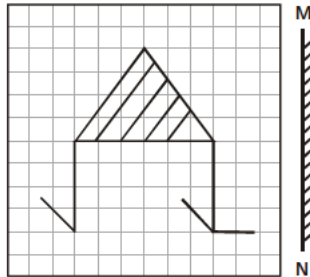

Answer Figures :

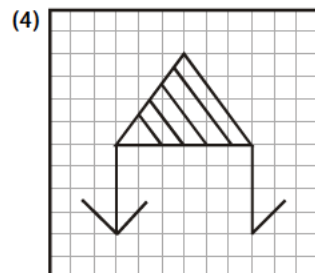
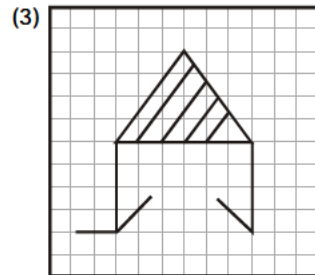
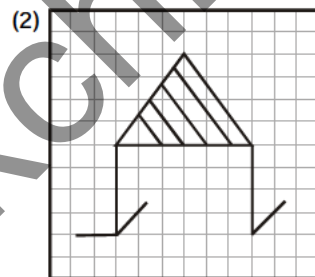
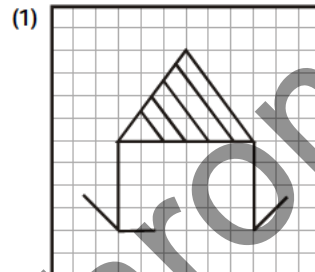

(SSC CGL Tier-I (CBE)
Exam. 01.09.2016) (IInd Sitting)

162. If a mirror is placed on the line MN, then which of the answer figures is the right image of the given figure?

Question Figure :

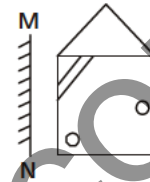

Answer Figures :

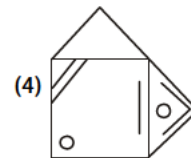
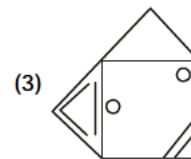
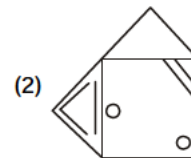
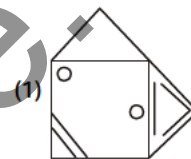

(SSC CGL Tier-I (CBE)
Exam. 02.09.2016) (IInd Sitting)

MIRROR & WATER IMAGES

163. If a mirror is placed on the line MN, then which of the answer figures is the right image of the given figure?

Question Figure :

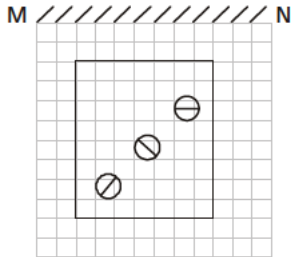

Answer Figures :

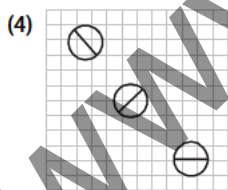
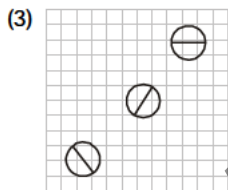
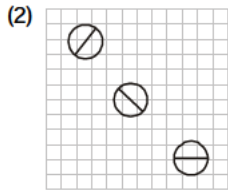
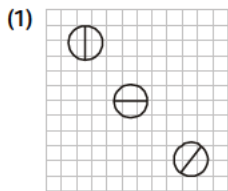

(SSC CGL Tier-I (CBE)
Exam. 03.09.2016) (IIIrd Sitting)

164. If a mirror is placed on the line MN, then which of the answer figures is the right image of the given figure?

Question Figure :

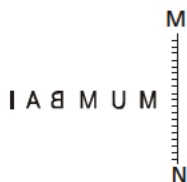

- (1) ABMUMI (2) BMUMIA
(3) MUMIAB (4) MUMBAI

(SSC CGL Tier-I (CBE)
Exam. 04.09.2016) (IIIrd Sitting)

165. If a mirror is placed on the line MN, then which of the answer figures is the right image of the given figure?

Question Figure :

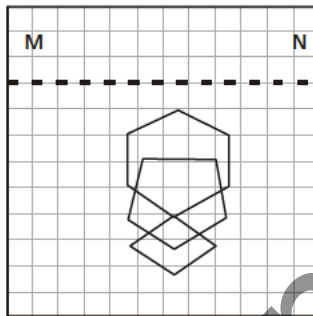

Answer Figures :

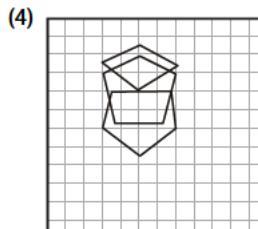
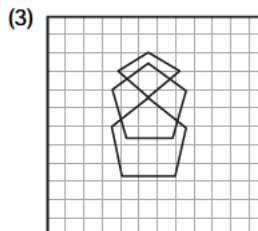
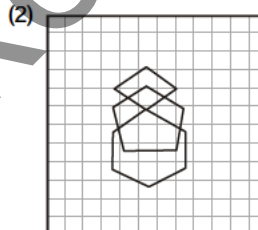
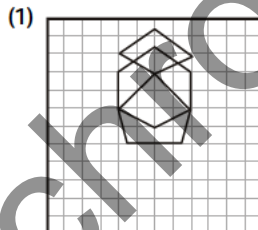

(SSC CGL Tier-I (CBE)
Exam. 06.09.2016) (IIIrd Sitting)

166. If a mirror is placed on the line MN, then which of the answer figures is the right image of the given figure?

Question Figure :

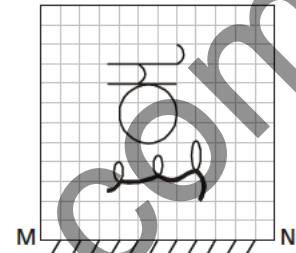

Answer Figures :

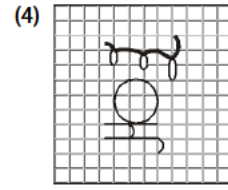
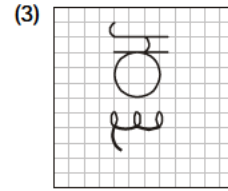
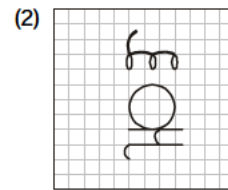
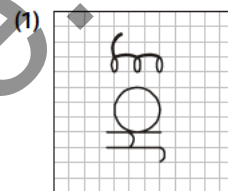

(SSC CGL Tier-I (CBE)
Exam. 07.09.2016) (IIIrd Sitting)

167. If a mirror is placed on the line MN, then which of the answer figures is the right image of the given figure?

Question Figure :

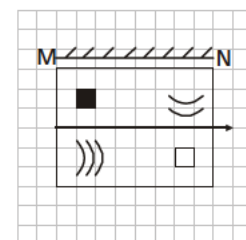

MIRROR & WATER IMAGES

Answer Figures :

- (1)
- (2)
- (3)
- (4)

(SSC CGL Tier-I (CBE)
Exam. 08.09.2016) (IIIrd Sitting)

168. If a mirror is placed on the line MN, then which of the answer figures is the right image of the given figure?

Question Figure :

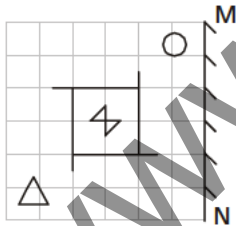

Answer Figures :

- (1)
- (2)
- (3)

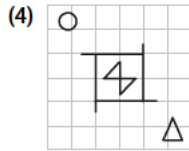

(SSC CGL Tier-I (CBE)
Exam. 09.09.2016) (IIInd Sitting)

169. If a mirror is placed on the line MN, then which of the answer figures is the right image of the given figure?

Question Figure :

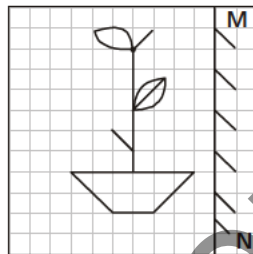

Answer Figures :

- (1)
- (2)
- (3)
- (4)

(SSC CGL Tier-I (CBE)
Exam. 10.09.2016) (IIIrd Sitting)

170. If a mirror is placed on the line MN, then which of the answer figures is the right image of the given figure?

Question Figure :

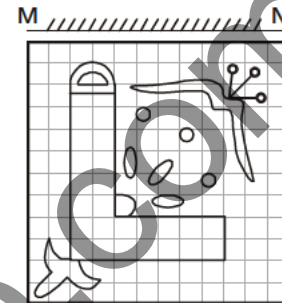

Answer Figures :

- (1)
- (2)
- (3)
- (4)

(SSC CGL Tier-I (CBE)
Exam. 11.09.2016) (IIInd Sitting)

MIRROR & WATER IMAGES

171. If a mirror is placed on the line MN, then which of the answer figures is the right image of the given figure?

Question Figure :

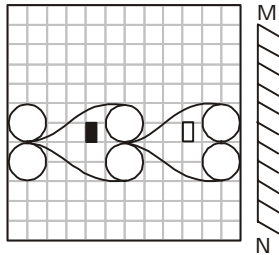

Answer Figures :

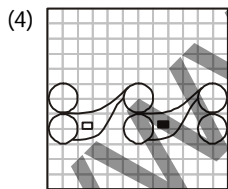
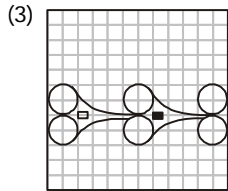
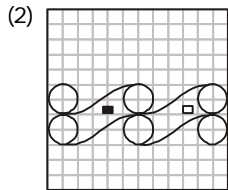
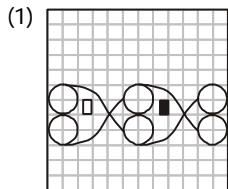

(SSC CGL Tier-I (CBE)
Exam. 03.09.2016) (IInd Sitting)

172. If a mirror is placed on the line MN, then which of the answer figures is the right image of the given figure?

Question Figure :

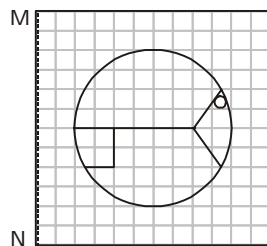

Answer Figures :

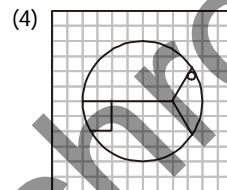
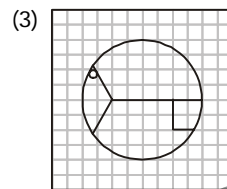
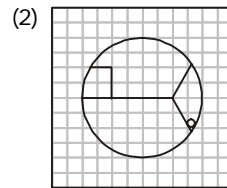
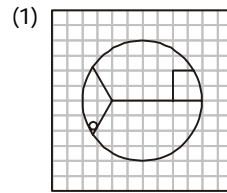

(SSC CGL Tier-I (CBE)
Exam. 04.09.2016) (IInd Sitting)

173. If a mirror is placed on the line MN, then which of the answer figures is the right image of the given figure?

Question Figure :

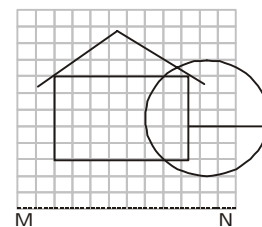

Answer Figures :

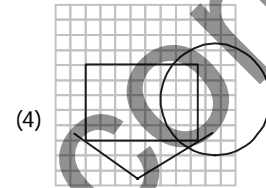
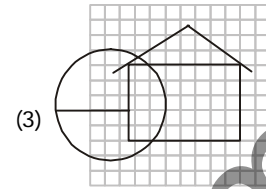
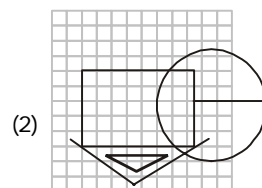
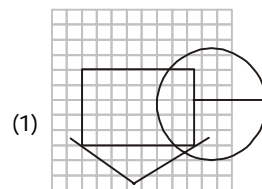

(SSC CGL Tier-I (CBE)
Exam. 06.09.2016) (IInd Sitting)

174. If a mirror is placed on the line MN, then which of the answer figures is the right image of the given figure ?

Question Figure

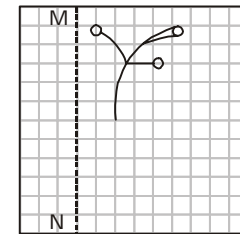

Answer Figures

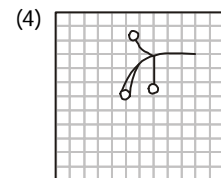
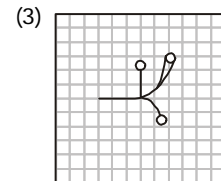
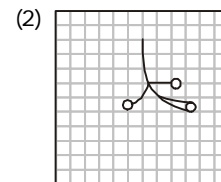
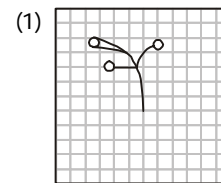

(SSC CGL Tier-I (CBE)
Exam. 07.09.2016) (IInd Sitting)

MIRROR & WATER IMAGES

175. If a mirror is placed on the line MN, then which of the answer figures is the right image of the given figure ?

Question Figure :

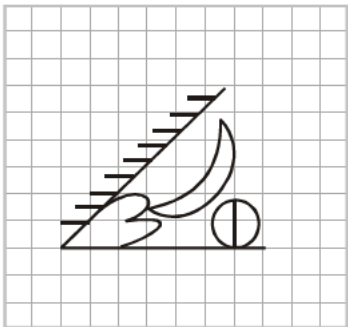

Answer Figures :

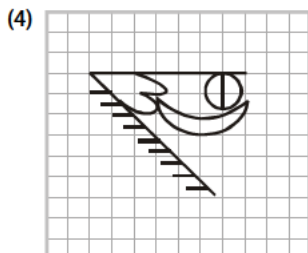
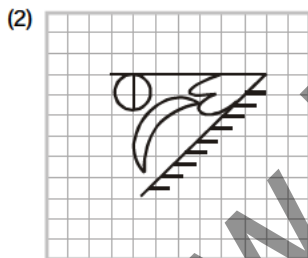
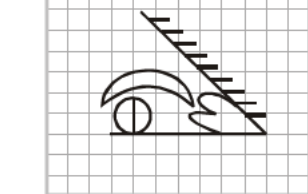
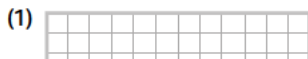

(SSC CGL Tier-I (CBE) Exam. 08.09.2016) (IInd Sitting)

176. If a mirror is placed on the line MN, then which of the answer figures is the right image of the given figure?

Question Figure :



Answer Figures :

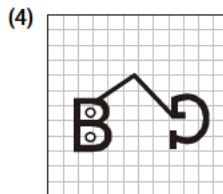
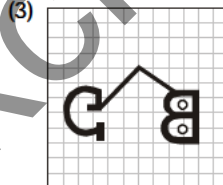
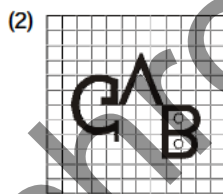
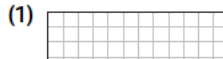

(SSC CGL Tier-I (CBE) Exam. 09.09.2016) (IInd Sitting)

177. If a mirror is placed on the line MN, then which of the answer figures is the right image of the given figure ?

Question Figure :

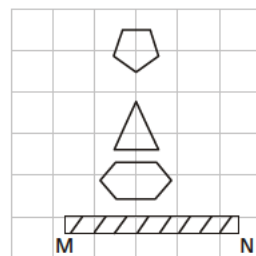

Answer Figures :

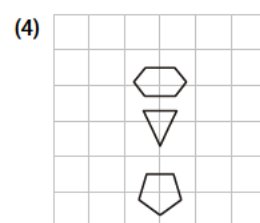
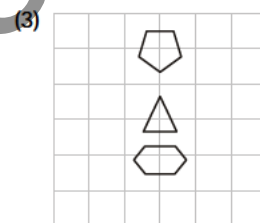
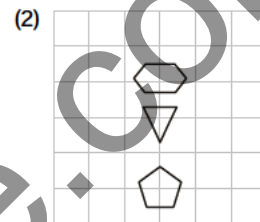
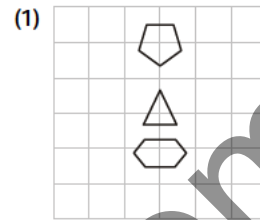

(SSC CGL Tier-I (CBE) Exam. 10.09.2016) (IInd Sitting)

178. If a mirror is placed on the line MN, then which of the answer figures is the right image of the given figure?

Question Figure :

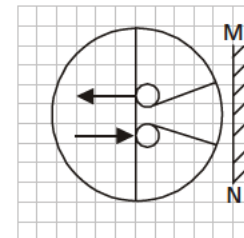

Answer Figures :

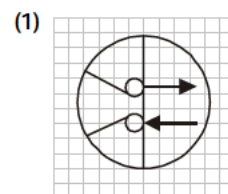

MIRROR & WATER IMAGES

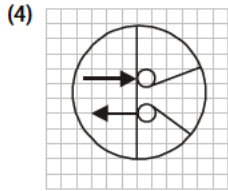
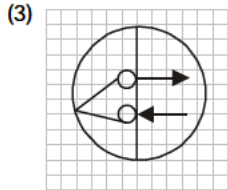
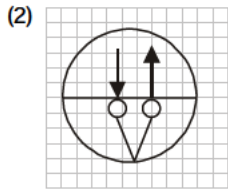

(SSC CGL Tier-I (CBE)
Exam. 11.09.2016) (IInd Sitting)

179. If a mirror is placed on the line MN, then which of the answer figures is the right image of the given figure?

Question Figure :

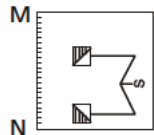

Answer Figures :

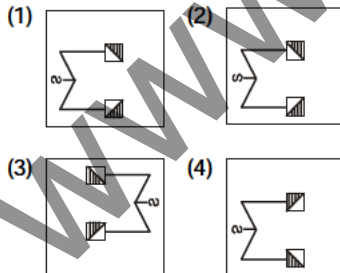

(SSC CGL Tier-I (CBE)
Exam. 27.10.2016) (1st Sitting)

180. If a mirror is placed on the line MN, then which of the answer figures is the right image of the given figure?

Question Figure :

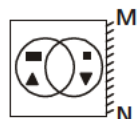

Answer Figures :

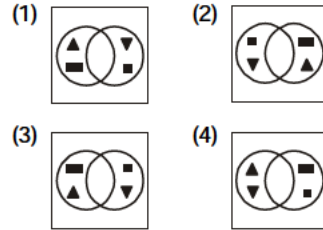

(SSC CGL Tier-I (CBE)
Exam. 27.10.2016) (IInd Sitting)

181. If a mirror is placed on the line MN, then which of the answer figures is the right image of the given figure?

Question Figure :

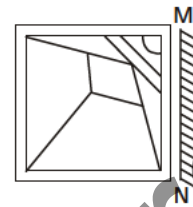

Answer Figures :

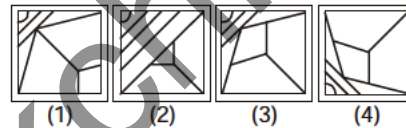

(SSC CHSL (10+2) Tier-I (CBE)
Exam. 15.01.2017) (IInd Sitting)

182. If a mirror is placed on the line MN, then which of the answer figures is the right image of the given figure?

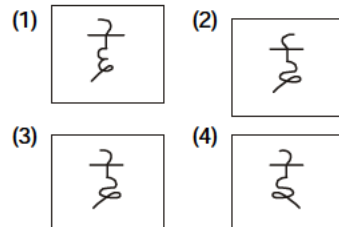
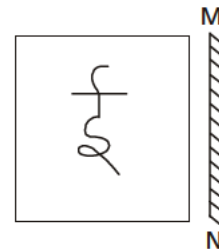

(SSC CHSL (10+2) Tier-I (CBE)
Exam. 16.01.2017) (IInd Sitting)

183. If a mirror is placed on the line MN, then which of the answer figures is the right image of the given figure?

Question Figure :

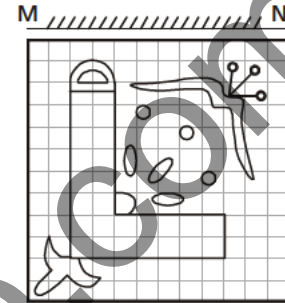

Answer Figures :

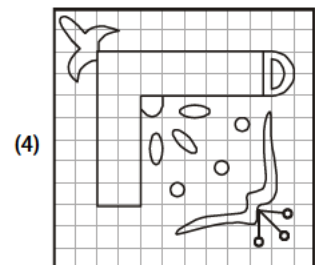
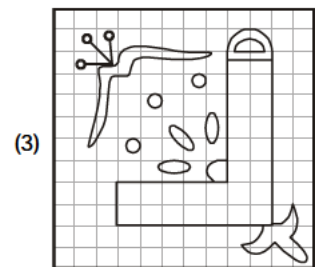
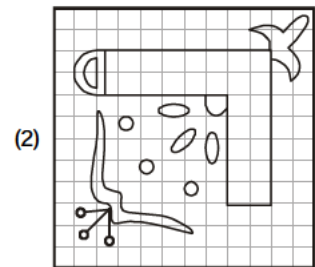
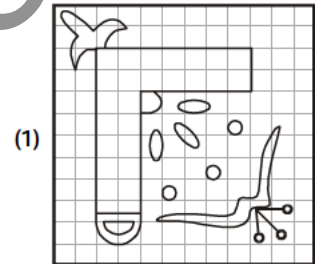

(SSC CGL Tier-I (CBE)
Exam. 11.09.2016) (1st Sitting)

MIRROR & WATER IMAGES

184. If a mirror is placed on the line MN, then which of the answer figures is the correct image of the question figure ?

Question Figure

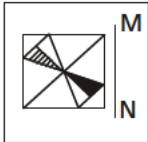

Answer Figures

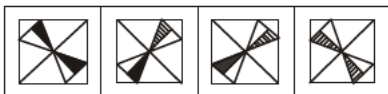

(1) (2) (3) (4)

(SSC Multi-Tasking Staff Exam. 30.04.2017 1st Sitting)

TYPE-II

1. Choose the correct water image of the figure from responses given below ?

Question Figure



Answer Figures

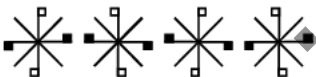

(1) (2) (3) (4)

(SSC Combined Graduate Level Prelim Exam. 04.07.1999 (First Sitting))

2. Choose the correct image of the figure when seen in water from the responses given below :

Question Figure



Answer Figures

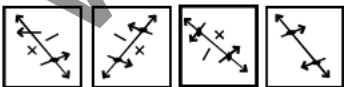

(1) (2) (3) (4)

(SSC Combined Graduate Level Prelim Exam. 04.07.1999 (IInd Sitting))

3. Choose the correct water-image of the figure from responses given below :

Question Figure



Answer Figures :

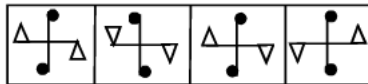

(1) (2) (3) (4)

(SSC Combined Matric Level (PRE) Exam. 21.05.2000 (1st Sitting) (Middle Zone))

4. Choose the correct water image of the question figure out of the four answer figures given :

Question Figure



Answer Figures :

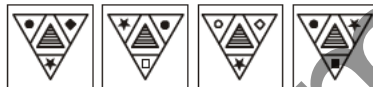

(1) (2) (3) (4)

(SSC Combined Matric Level (Pre) Exam. 30.07.2006 (1st Sitting) (East Zone))

5. Choose the correct water image of the question figure out of four answer figures given :

Question Figure



Answer Figures :



(1) (2) (3) (4)

(SSC Combined Matric Level (Pre) Exam. 30.07.2006 (IInd Sitting) (Central Zone))

6. Choose the right water-image of the question figure from the given answer figures.

Question Figure

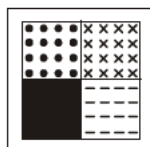

Answer Figures :

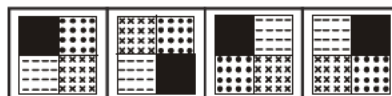

(1) (2) (3) (4)

(SSC Graduate Level Tier-I Exam. 19.05.2013, 1st Sitting)

7. Which of the answer figures is exactly the water image of the given figure ?

Question Figure



Answer Figures :



(1) (2) (3) (4)

(SSC CGL Tier-I Re-Exam-2013, 27.04.2014)

8. Find water image of :

Question Figure



Answer Figures

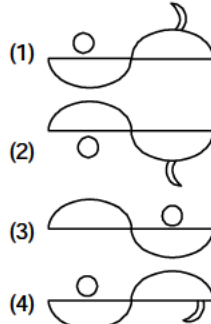

(SSC CHSL (10+2) LDC, DEO & PA/SA Exam, 15.11.2015 (1st Sitting) TF No. 6636838)

9. Which one of the following is water image of "COMMISSION"

- (1) NOISSIMMO
- (2) COMMISSION
- (3) COMMISSION
- (4) NOISSIMMO

(SSC CHSL (10+2) LDC, DEO & PA/SA Exam, 06.12.2015 (IInd Sitting) TF No. 3441135)

MIRROR & WATER IMAGES

ANSWERS

TYPE-I

1. (2)	2. (3)	3. (2)	4. (3)
5. (3)	6. (4)	7. (2)	8. (2)
9. (2)	10. (3)	11. (3)	12. (3)
13. (1)	14. (4)	15. (3)	16. (4)
17. (1)	18. (4)	19. (1)	20. (1)
21. (2)	22. (1)	23. (4)	24. (1)
25. (3)	26. (4)	27. (4)	28. (3)
29. (3)	30. (4)	31. (4)	32. (1)
33. (3)	34. (1)	35. (1)	36. (1)
37. (1)	38. (4)	39. (4)	40. (3)
41. (1)	42. (3)	43. (4)	44. (2)
45. (2)	46. (2)	47. (2)	48. (1)
49. (1)	50. (2)	51. (1)	52. (4)
53. (4)	54. (1)	55. (2)	56. (1)
57. (4)	58. (4)	59. (3)	60. (4)
61. (4)	62. (4)	63. (3)	64. (3)
65. (3)	66. (2)	67. (2)	68. (2)
69. (2)	70. (1)	71. (1)	72. (2)
73. (3)	74. (3)	75. (3)	76. (4)
77. (3)	78. (3)	79. (2)	80. (3)
81. (3)	82. (3)	83. (2)	84. (3)
85. (4)	86. (1)	87. (2)	88. (2)
89. (4)	90. (3)	91. (1)	92. (3)
93. (3)	94. (1)	95. (2)	96. (4)
97. (3)	98. (3)	99. (4)	100. (2)
101. (2)	102. (3)	103. (4)	104. (3)
105. (3)	106. (2)	107. (4)	108. (2)
109. (1)	110. (1)	111. (3)	112. (1)
113. (3)	114. (2)	115. (2)	116. (2)
117. (2)	118. (2)	119. (1)	120. (4)
121. (1)	122. (1)	123. (1)	124. (3)
125. (1)	126. (3)	127. (3)	128. (2)
129. (4)	130. (3)	131. (3)	132. (2)
133. (3)	134. (4)	135. (3)	136. (3)
137. (3)	138. (1)	139. (1)	140. (2)
141. (3)	142. (1)	143. (4)	144. (3)

145. (1)	146. (1)	147. (4)	148. (2)
149. (3)	150. (4)	151. (1)	152. (4)
153. (2)	154. (1)	155. (4)	156. (2)
157. (4)	158. (2)	159. (3)	160. (3)
161. (2)	162. (2)	163. (4)	164. (4)
165. (2)	166. (4)	167. (2)	168. (2)
169. (3)	170. (1)	171. (1)	172. (3)
173. (1)	174. (1)	175. (3)	176. (2)
177. (2)	178. (1)	179. (1)	180. (2)
181. (3)	182. (3)	183. (1)	184. (3)

TYPE-II

1. (2)	2. (2)	3. (3)	4. (4)
5. (4)	6. (3)	7. (2)	8. (1)
9. (2)			

EXPLANATIONS

TYPE-I

1. (2)



2. (3)



3. (2)



4. (3)



5. (3)



6. (4) In water image upside becomes downside.



7. (2)



8. (2)



9. (2)



10. (3)



11. (3)



12. (3)



13. (1)



14. (4)



15. (3)



16. (4)



17. (1)



18. (4)



19. (1)



20. (1)



Real Time
2:15

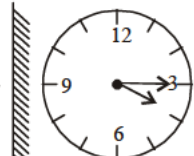
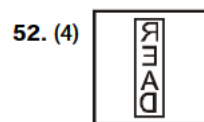
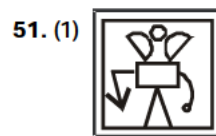
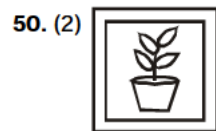
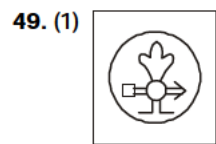
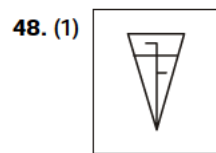
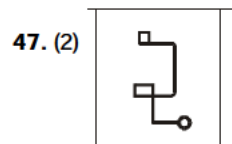
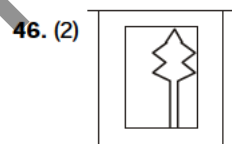
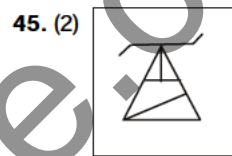
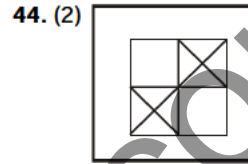
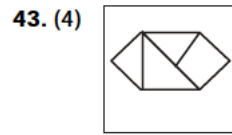
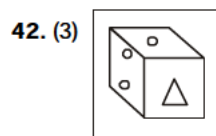
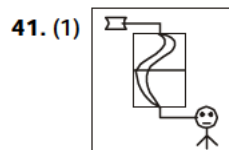
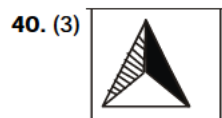
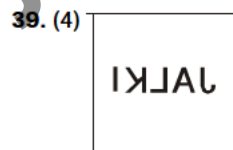
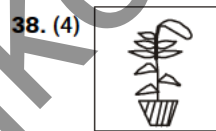
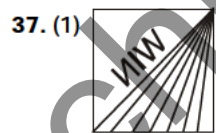
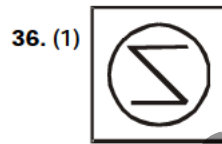
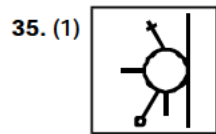
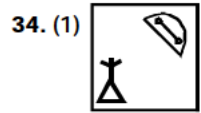
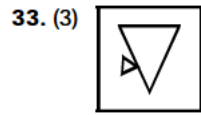
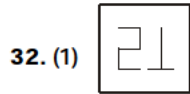
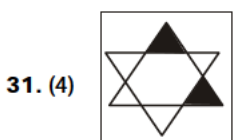
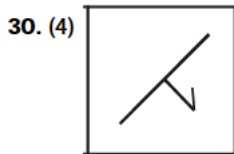
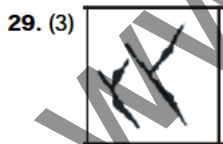
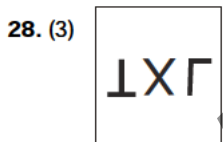
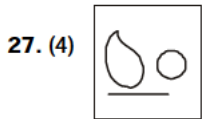
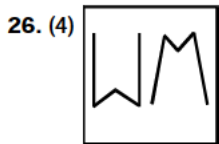
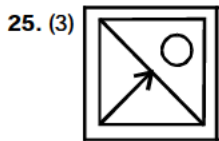
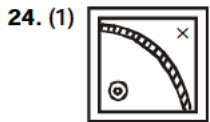
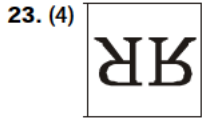
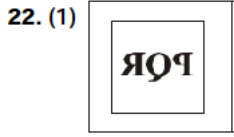

Image
4:15

21. (2)



MIRROR & WATER IMAGES



MIRROR & WATER IMAGES

53. (4)



54. (1)



55. (2)



56. (1) FROWNING

57. (4)



58. (4) WINCHESTER

59. (3) APRIL

60. (4) MISSION

61. (4)



62. (4) SEPTEMBER

63. (3) JUNE

64. (3) WATER

65. (3)



66. (2)



67. (2)



68. (2)



69. (2)



70. (1)

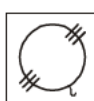

71. (1)



72. (2)



73. (3)



74. (3)



75. (3)



76. (4)



77. (3)



78. (3)



79. (2)



80. (3)



81. (3)



82. (3) P R A Y E R

83. (2)



84. (3)



85. (4)



86. (1)



87. (2)

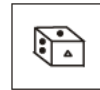

88. (2) EVOM

89. (4)



90. (3)



91. (1)



92. (3)

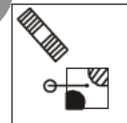

93. (3)



94. (1)



95. (2)



96. (4)



97. (3)



98. (3)



99. (4)

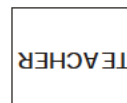

100. (2) 4 2 4

101. (2) DANIEL

102. (3)



103. (4) 4 2 4

104. (3) SECRETARY

MIRROR & WATER IMAGES

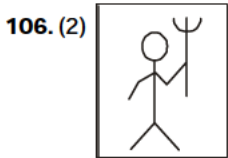
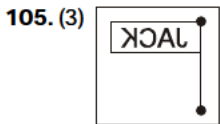

107. (4) ENDURANCE

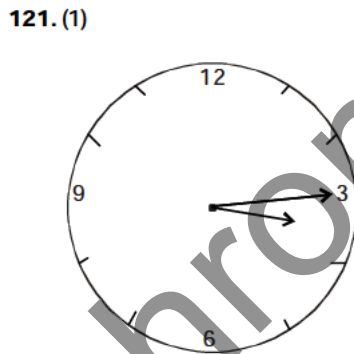
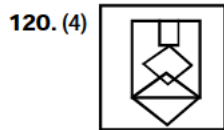
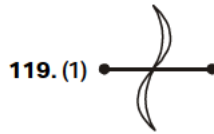
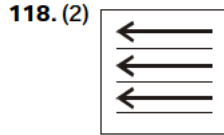
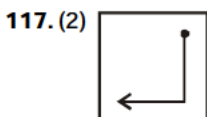
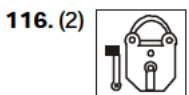
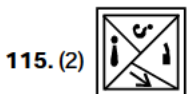
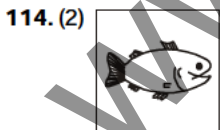
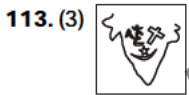
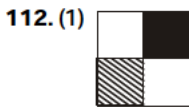
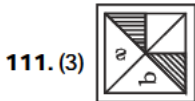
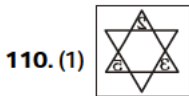
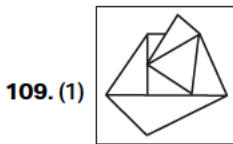
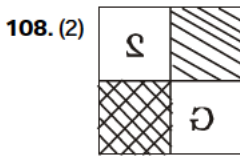

If the image of a clock in a mirror is seen as 3.15, the right time would be 8.45.

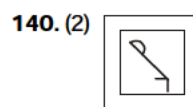
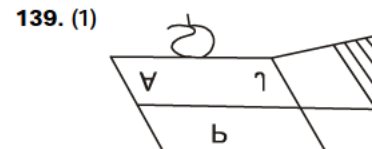
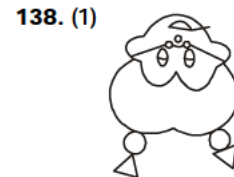
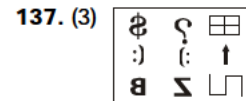
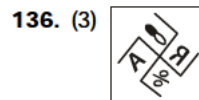
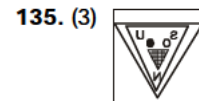
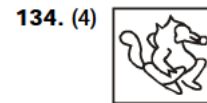
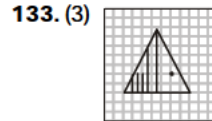
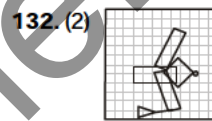
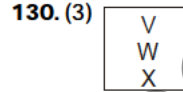
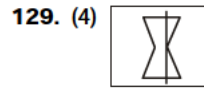
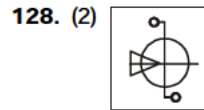
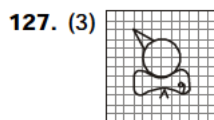
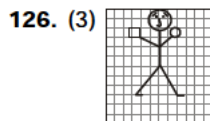
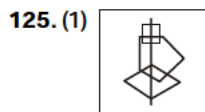
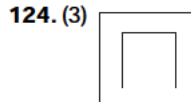
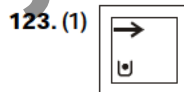
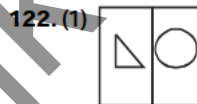

MIRROR & WATER IMAGES

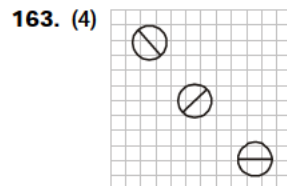
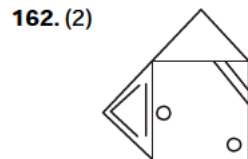
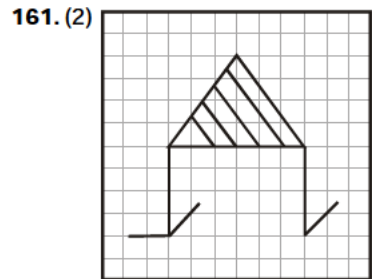
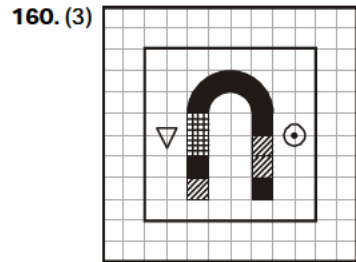
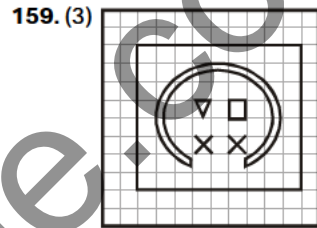
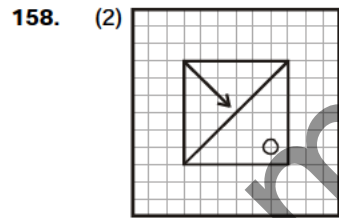
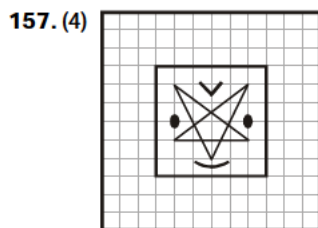
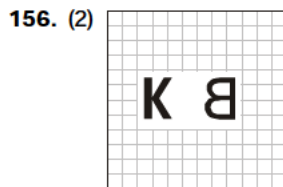
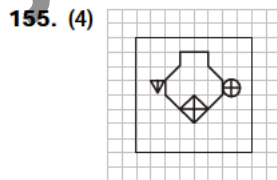
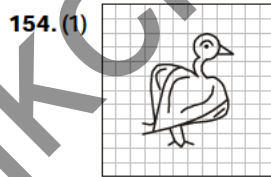
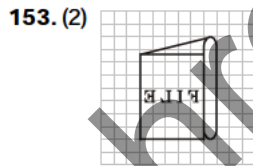
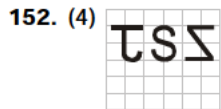
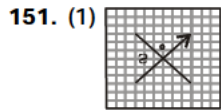
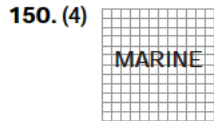
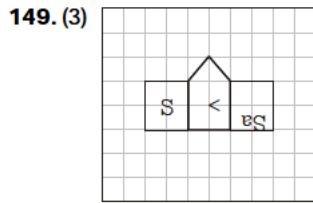
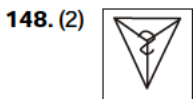
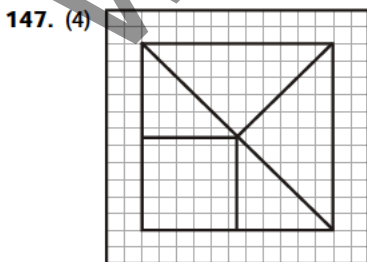
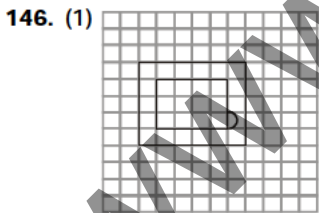
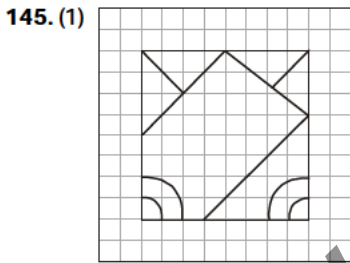
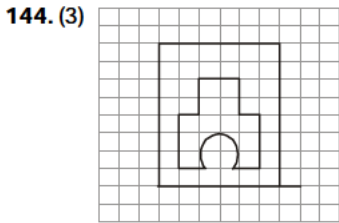
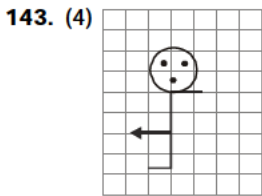
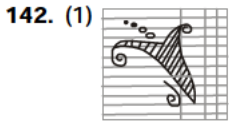
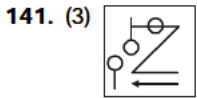

164. (4) MUMBAI

MIRROR & WATER IMAGES

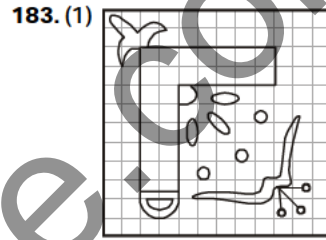
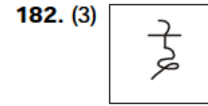
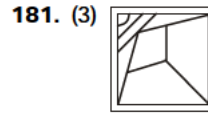
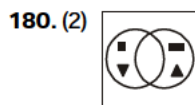
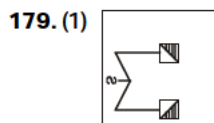
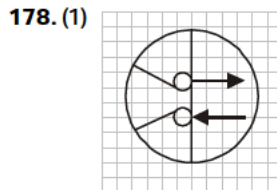
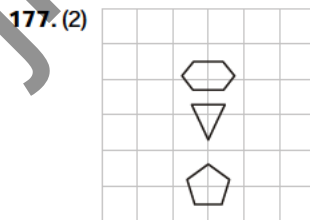
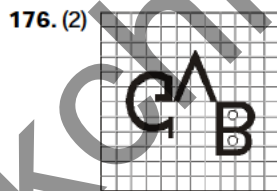
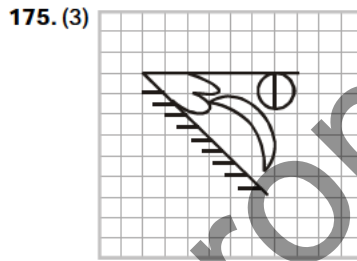
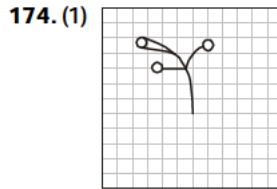
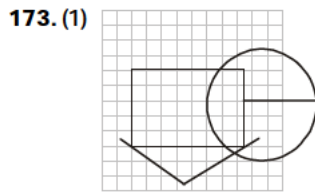
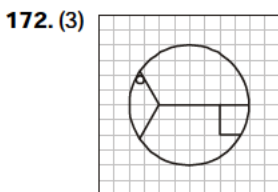
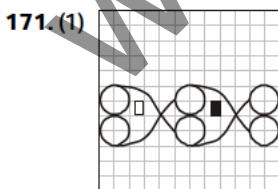
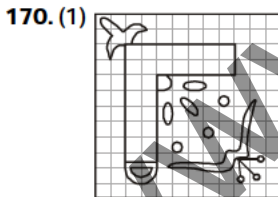
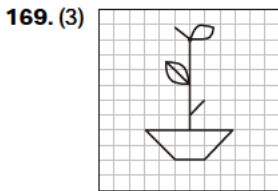
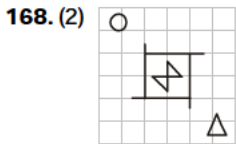
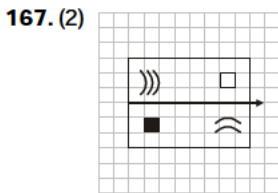
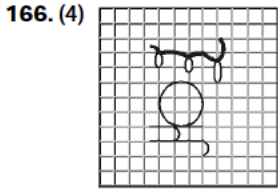
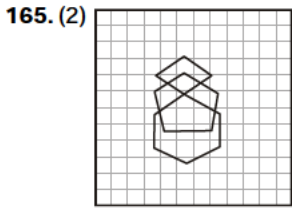

TYPE-II

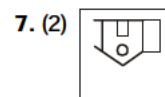
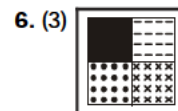
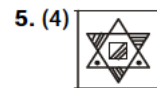
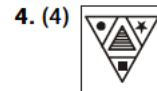
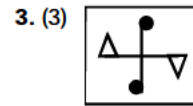
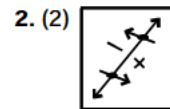
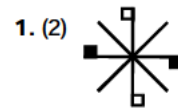

9. (2) COMMISSION



JK Chrome

JK Chrome | Employment Portal



Rated No.1 Job Application of India

Sarkari Naukri
Private Jobs
Employment News
Study Material
Notifications



JOBS



NOTIFICATIONS



G.K



STUDY MATERIAL

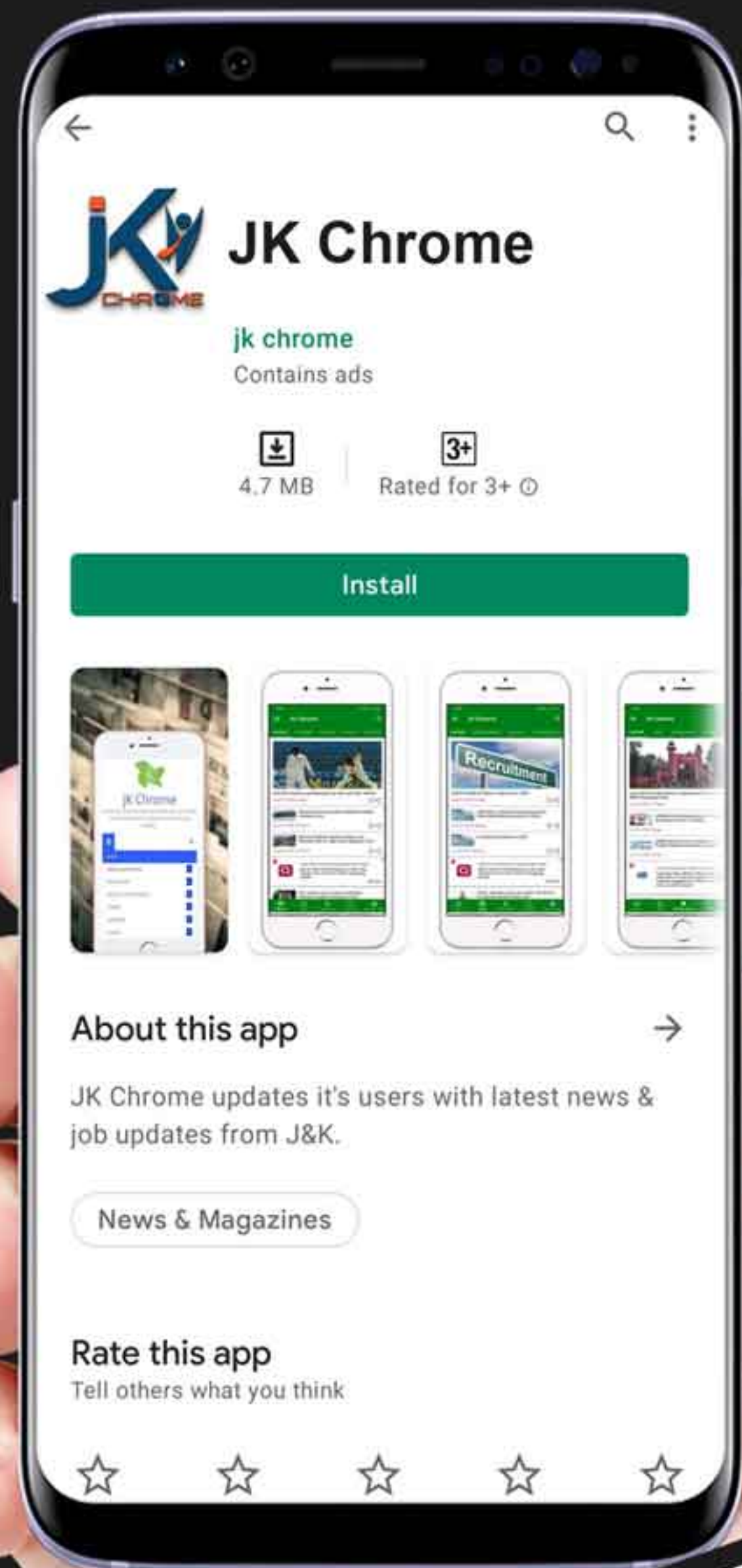

JK Chrome

jk chrome
Contains ads



www.jkchrome.com | Email : contact@jkchrome.com