



JK Chrome

JK Chrome | Employment Portal



Rated No.1 Job Application of India

Sarkari Naukri
Private Jobs
Employment News
Study Material
Notifications



JOBS



NOTIFICATIONS



G.K



STUDY MATERIAL

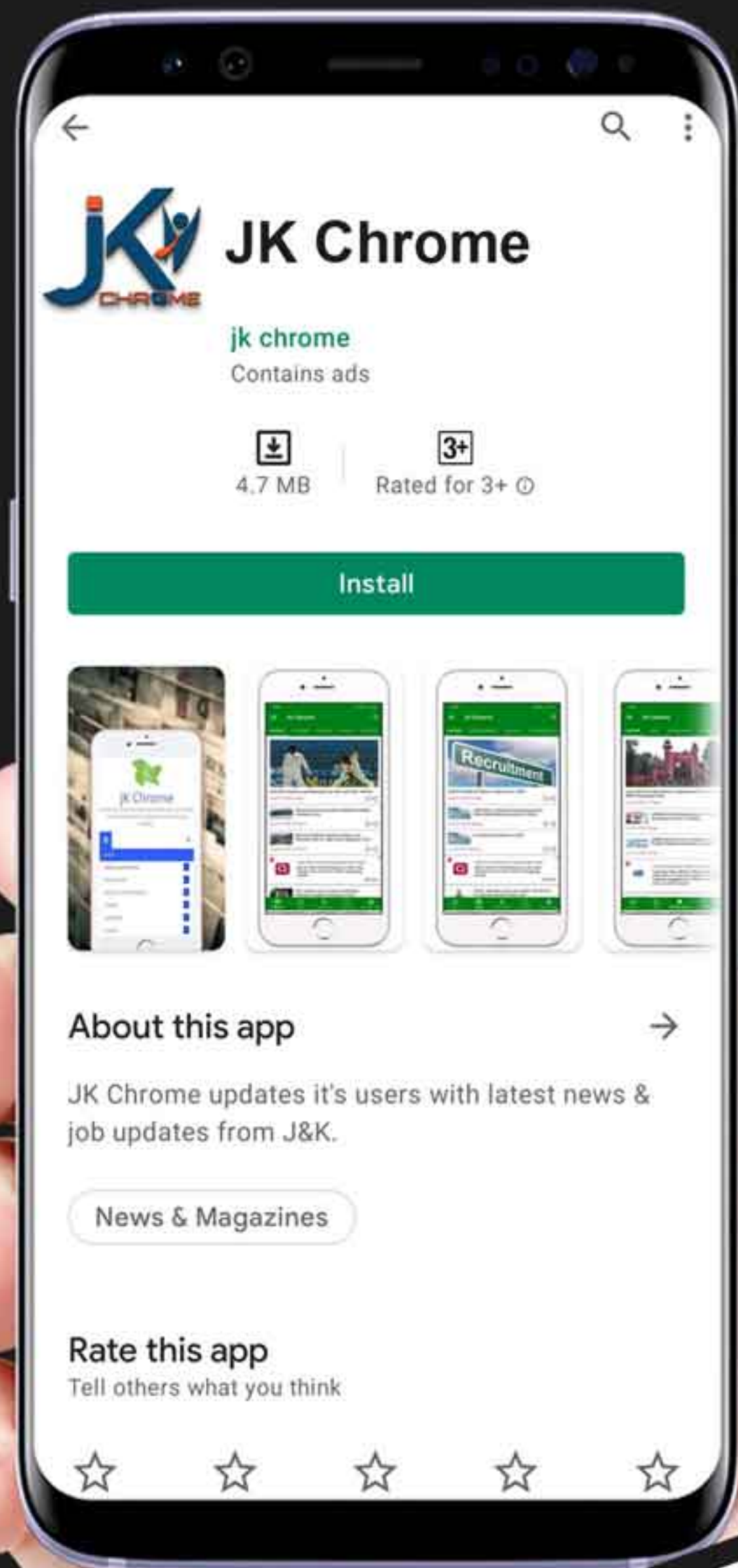

JK Chrome

jk chrome
Contains ads



www.jkchrome.com | Email : contact@jkchrome.com

DIRECTIONS (Qs. 1-6) : In each of the following questions, select the one which is different from the other three responses.

(SSC CGL 1st Sit. 2010)

1. (a) 25, 36 (b) 144, 169
(c) 100, 121 (d) 9, 64
2. (a) Heat (b) Light
(c) Bulb (d) Electricity
3. (a) Wave (b) Current
(c) Tide (d) Storm
4. (a) X (b) Y
(c) H (d) D
5. (a) ZKXJ (b) CMAL
(c) TGRF (d) FRITK
6. (a) ABJNM (b) QRTUZ
(c) IXYOQ (d) WFGOP

DIRECTIONS (7-13) : In each of the following questions find the odd word/letters/number from the given responses.

(SSC CGL 1st Sit. 2010)

7. (a) Room (b) Chamber
(c) Veranda (d) Cabin
8. (a) Mouth Organ (b) Electric Guitar
(c) Keyboard (d) Sonata
9. (a) A (b) I
(c) D (d) E
10. (a) RNMP (b) JFEH
(c) RPOQ (d) HDCE
11. (a) AbcdE (b) IfghO
(c) ApqrL (d) UlmnE
12. (a) 6243 (b) 2643
(c) 8465 (d) 4867
13. (a) 49-33 (b) 62-46
(c) 83-67 (d) 70-55

DIRECTIONS (Qs. 14-19) : In each of the following questions, find the odd number / letters/ word from the given alternatives.

(SSC CGL 1st Sit. 2011)

14. (a) Flute (b) Violin
(c) Guitar (d) Sitar
15. (a) Prod (b) Sap
(c) Jab (d) Thrust
16. (a) JKOP (b) MNST
(c) CABD (d) OPWX
17. (a) CAFD (b) TSWV
(c) IGLJ (d) OMRP
18. (a) 162 (b) 405
(c) 567 (d) 644

19. (a) 156 (b) 201
(c) 273 (d) 345
20. Find out the pair of numbers that does not belong to the group for lack of common property. (SSC CGL 2nd Sit. 2011)
(a) 11-115 (b) 10-90
(c) 9-72 (d) 8-56

DIRECTIONS (Qs. 21-26) : In question, find the odd number/ letters/ number pair from the given alternatives.

(SSC CGL 2nd Sit. 2011)

21. (a) Softball (b) Baseball
(c) Cricket (d) Basketball
22. (a) Annoy (b) Distress
(c) Harass (d) Ravage
23. (a) PRSU (b) SUWY
(c) HJLN (d) CEGI
24. (a) YDWB (b) TKRI
(c) QNOM (d) HLFJ
25. (a) Tomato (b) Potato
(c) Carrot (d) Onion
26. (a) 125 (b) 789
(c) 236 (d) 347
27. Find out the pair of numbers that does not belong to the group for lack of common property. (SSC CGL 2nd Sit. 2011)
(a) 16-18 (b) 56-63
(c) 96-108 (d) 86-99

DIRECTIONS (Qs. 28-35) : In questions, find the odd number/ letters/ word/ number pair from the given alternatives.

(SSC CGL 1st Sit. 2012)

28. (a) SP (b) NL
(c) ZW (d) TQ
29. (a) Major (b) Colonel
(c) Brigadier (d) Admiral
30. (a) Life Insurance Corporation.
(b) New India Assurance Company Ltd.
(c) United India Insurance Company Ltd.
(d) National Insurance Company Ltd.
31. (a) Hurdle (b) Disease
(c) Barrier (d) Obstacle
32. (a) Mar (b) Remedy
(c) Maim (d) Mutilate
33. (a) Socrates (b) Beethoven
(c) Mozart (d) Bach

34. (a) (132, 5) (b) (125, 8)
 (c) (124, 7) (d) (112, 4)
35. (a) 6246–6296 (b) 7137–7267
 (c) 4344–4684 (d) 5235–5465

DIRECTIONS (Qs. 36-46): In questions, find the odd number/ letters/number pair from the given alternatives.

(SSC CGL 1st Sit. 2012)

36. (a) 72 (b) 81
 (c) 93 (d) 66
37. (a) (125, 27) (b) (64, 216)
 (c) (216, 02) (d) (343, 01)
38. (a) Division (b) Addition
 (c) Subtract (d) Multiplication
39. (a) 47 (b) 17
 (c) 27 (d) 37
40. (a) 5270–2936 (b) 186–69
 (c) 168–570 (d) 1001–100
41. (a) 8 5 3 6 2 (b) 6 3 8 5 2
 (c) 5 2 6 3 8 (d) 2 8 7 5 1
42. (a) VEIIDD (b) IVEF
 (c) VEENS (d) EINN
43. (a) Arunachal Pradesh
 (b) Jammu and Kashmir
 (c) Haryana
 (d) Himachal Pradesh
44. (a) Size (b) Number
 (c) Form (d) Weight
45. (a) Fish (b) Frog
 (c) Tortoise (d) Crab
46. (a) Board (b) Commission
 (c) Team (d) Agenda

DIRECTIONS (Qs. 47-55): In each of the following questions, find the odd word/number/letters/word/number pair from the given alternatives.

(SSC CGL 2nd Sit. 2012)

47. (a) VWY (b) QRT
 (c) LMO (d) JKL
48. (a) BE (b) GJ
 (c) NP (d) QR
49. (a) 400 (b) 484
 (c) 625 (d) 729
50. (a) 1000 (b) 1725
 (c) 2744 (d) 4096
51. (a) 12–16 (b) 60–80
 (c) 30–50 (d) 36–48
52. (a) CX (b) DW
 (c) JQ (d) LR
53. (a) Cyclotron (b) Basic
 (c) Pascal (d) Fortran
54. (a) Rooster (b) Buck
 (c) Gander (d) Peahen
55. (a) Booklet (b) Pamphlet
 (c) Voucher (d) Brochure

DIRECTIONS (Qs. 56 - 64): Find the odd number / letters / number pair from the given alternatives.

(SSC CGL 2nd Sit. 2012)

56. (a) Pathology (b) Geology
 (c) Cardiology (d) Radiology
57. (a) Rivulet (b) Stream
 (c) River (d) Pond
58. (a) Konark (b) Madurai
 (c) Dilwara (d) Ellora
59. (a) RTW (b) QOM
 (c) IKG (d) IKM
60. (a) EFH (b) OPQ
 (c) BCE (d) IJL
61. (a) DH (b) FJ
 (c) HK (d) PR
62. (a) 24 (b) 49
 (c) 80 (d) 15
63. (a) 121 (b) 324
 (c) 523 (d) 729
64. (a) 704, 11 (b) 256, 4
 (c) 832, 13 (d) 310, 5

DIRECTIONS (Qs. 65-72): In question, find the odd word/ number/letters from the given alternatives.

(SSC Sub. Ins. 2012)

65. (a) Sparrow (b) Kingfisher
 (c) Nightingale (d) Bat
66. (a) Dive (b) Trench
 (c) Canal (d) Ditch
67. (a) 206 (b) 125
 (c) 27 (d) 8
68. (a) Shack (b) Barn
 (c) Stable (d) Barrack
69. (a) GALLOP (b) SINK
 (c) ALBINO (d) CRAB
70. (a) Crew (b) Company
 (c) Army (d) Ants
71. (a) eMnT (b) iRsL
 (c) oKsZ (d) vGtN
72. 1. 1, 2, 4, 5 2. 6, 7, 14, 15
 3. 3, 4, 8, 9 4. 4, 5, 10, 12
 (a) 1 (b) 3
 (c) 4 (d) 2

DIRECTIONS (Qs. 73 - 78): Select the one which is different from the other three responses.

(SSC CHSL 2012)

73. (a) steering wheel (b) engine
 (c) ... (d) ...
74. (a) 325 (b) 360
 (c) 230 (d) 256
75. (a) NLM (b) YXZ
 (c) NMO (d) RQS
76. (a) uranus (b) pluto
 (c) jupiter (d) sun
77. (a) 12–48 (b) 18–54
 (c) 16–64 (d) 14–56
78. (a) LRO (b) CIG
 (c) SZW (d) PWT

DIRECTIONS (Qs. 79-82): In question, find the odd word/ number from the given alternatives.

(SSC CGL 1st Sit. 2013)

79. (a) Franc (b) Pound (sterling)
 (c) Deutsche Mark (d) Yen
80. (a) Yellow Green (b) Yellow Orange
 (c) Red Yellow (d) Red Orange
81. (a) fastidious (b) firm
 (c) grave (d) agreeable
82. 27, 125, 216, 343
 (a) 27 (b) 125
 (c) 216 (d) 343

DIRECTIONS (Qs. 83-88) : Select the one which is different from the other three responses.

(SSC CGL 1st Sit. 2013)

83. (a) Shimla (b) Darjeeling
 (c) Ooty (d) Agra
84. (a) Foal (b) Hen
 (c) Lamb (d) Leveret
85. (a) BADC (b) XWZY
 (c) VUST (d) NMPO
86. (a) DCFG (b) FEHI
 (c) JILM (d) HGJL
87. (a) (1, 0) (b) (2, 3)
 (c) (3, 8) (d) (4, 27)
88. (a) (96, 24) (b) (39, 18)
 (c) (81, 54) (d) (82, 64)

DIRECTIONS (Qs. 89-93): In question, find the odd word/number/number pair from the given alternatives.

(SSC CGL 2nd Sit. 2013)

89. (a) Rickets (b) Night-blindness
 (c) Influenza (d) Scurvy
90. (a) Shower (b) Sleet
 (c) Raisin (d) Rain
91. (a) 71 – 55 (b) 517 – 523
 (c) 248 – 231 (d) 547 – 563
92. 10, 13, 234, 681, 997
 (a) 234 (b) 13
 (c) 681 (d) 10
93. (a) Heed (b) Led
 (c) Heap (d) Head

DIRECTIONS (Qs. 94-97): Find the odd words/letters/number pair from the given alternatives.

(SSC CGL 2nd Sit. 2013)

94. (a) Fervent (b) Enthusiastic
 (c) Apathetic (d) Ardent
95. (a) FAA (b) OFF
 (c) ATT (d) EPP
96. (a) 117 – 143 (b) 142 – 156
 (c) 64 – 78 (d) 103 – 169
97. (a) Radio (b) Television
 (c) Transistor (d) Tube

DIRECTIONS (98-101) : In each of the following questions, select the one which is different, from other three responses.

(SSC CGL 2nd Sit. 2013)

98. (a) Soldier – Barrack (b) Principal – School
 (c) Artist – Troupe (d) Singer – Chorus
99. (a) Detach (b) Affix
 (c) Append (d) Fasten

100. (a) Man = 13114 (b) Ram = 18113
 (c) Jug = 10217 (d) Hub = 82110
101. (a) 74, 7 (b) 97, 9
 (c) 41, 4 (d) 63, 6

DIRECTIONS (Qs. 102-106) : In questions, select the one which is different from the other three responses.

(SSC Stenographer 2013)

102. (a) Nephew (b) Niece
 (c) Uncle (d) Father
103. (a) HAMF (b) VNYQ
 (c) KCOG (d) FKOR
104. (a) AIUE (b) PIRE
 (c) VALT (d) TORE
105. (a) 51 (b) 171
 (c) 291 (d) 322
106. (a) 80 (b) 120
 (c) 144 (d) 192

DIRECTIONS (Qs. 107-112): In the following questions, select the one which is different from the other three responses.

(SSC Sub. Ins. 2013)

107. (a) Teaching (b) Counselling
 (c) Instruction (d) Guidance
108. (a) (25, 49) (b) (121, 169)
 (c) (7, 169) (d) (9, 25)
109. (a) HEAT (b) MEAT
 (c) MEET (d) BEAT
110. (a) 8465 (b) 2643
 (c) 4867 (d) 6243
111. (a) FhjL (b) PrtV
 (c) KnpR (d) CegI
112. (a) Sitar (b) Violin
 (c) Tanpura (d) Veena

DIRECTIONS (Qs. 113 - 116): Find the odd number/word from the given alternatives.

(SSC Multitasking 2013)

113. (a) Madam (b) Animal
 (c) Othello (d) Noun
114. (a) 5 : 25 (b) 8 : 64
 (c) 7 : 49 (d) 6 : 30
115. (a) 245 (b) 443
 (c) 633 (d) 821
116. (a) Green gram (b) Millet
 (c) Barley (d) Wheat

DIRECTIONS (Qs. 117-120) : In questions, find the odd words /letters / number pair from the given alternatives.

(SSC CHSL 2013)

117. (a) Poet (b) Publisher
 (c) Author (d) Novelist
118. (a) KHEB (b) WTQN
 (c) MKHE (d) MIDA
119. (a) 41, 52 (b) 64, 73
 (c) 46, 57 (d) 38, 49

120. (a) Hexagon : Angle (b) Square : Line
(c) Circle : Arc (d) Line : Dot

DIRECTIONS (Qs. 121-126) : Find the odd letter/word/number pair from the given alternatives.

- (SSC Stenographer 2014)**
121. (a) Cricket (b) Football
(c) Polo (d) Hockey
122. (a) Tape recorder (b) TV
(c) Gramophone (d) Radio
123. (a) CDFE (b) RSTV
(c) JKML (d) MNPO
124. (a) 46-54 (b) 71-17
(c) 31-13 (d) 79-97
125. (a) T14 (b) T18
(c) T12 (d) T21
126. (a) ARBT (b) KVLW
(c) PXQY (d) EPFQ

DIRECTIONS (Qs. 127-132) : Find the odd word/number/ letters/ number pair from the given alternatives.

- (SSC CGL 1st Sit. 2014)**
127. (a) Obstetrician (b) Podiatrist
(c) Pulmonologist (d) Prosthetist
128. (a) Century (b) Decadent
(c) Year (d) Month
129. (a) FEDC (b) STUV
(c) LKJI (d) RQPO
130. (a) LPXOY (b) RQST
(c) FBDLX (d) MPONL
131. (a) 14 - 16 (b) 56 - 64
(c) 77 - 88 (d) 80 - 93
132. (a) 13 - 21 (b) 19 - 27
(c) 15 - 23 (d) 16 - 24

DIRECTIONS (Qs. 133-138) : In the following Six Questions, find the odd word/ number/ letters / number pair from the given alternatives.

- (SSC CGL 1st Sit. 2014)**
133. (a) Morning (b) Noon
(c) Evening (d) Night
134. (a) Liberty (b) Society
(c) Equality (d) Fraternity
135. (a) DWFU (b) EVHS
(c) HSKP (d) KQNN
136. (a) CBEF (b) EDGH
(c) IHKL (d) GFHJ
137. (a) 4025 (b) 7202
(c) 6023 (d) 5061
138. (a) 96 : 80 (b) 64 : 48
(c) 80 : 60 (d) 104 : 78

DIRECTIONS (Qs. 139-144) : In questions, find the odd word/ letters /numbers from the given alternatives.

- (SSC CGL 2nd Sit. 2014)**
139. (a) Lawyer (b) Legislator
(c) Mayor (d) Governor
140. (a) Acute (b) Parallel
(c) Right (d) Obtuse

141. (a) 50 (b) 120
(c) 37 (d) 145
142. (a) BS (b) EV
(c) DX (d) IZ
143. (a) OKHA (b) PERU
(c) ERKU (d) ANDI
144. (a) 200 (b) 191
(c) 808 (d) 1331

DIRECTIONS (Qs. 145-148) : In questions below, find the odd word/letters/number pair/figure from the given alternatives.

- (SSC Sub. Ins. 2014)**
145. (a) Tennis (b) Cricket
(c) Volleyball (d) Football
146. (a) Artificial (b) Insincere
(c) Affected (d) Naive
147. (a) 68 (b) 85
(c) 153 (d) 174
148. (a) 7 : 98 (b) 9 : 162
(c) 12 : 288 (d) 17 : 572

DIRECTIONS (Qs. 149-151) : In questions, select the one which is different from the other three alternatives.

- (SSC Multitasking 2014)**
149. (a) 42 - 49 (b) 35 - 62
(c) 63 - 70 (d) 28 - 21
150. (a) Engineer (b) School
(c) Lawyer (d) Doctor
151. (a) SRPQ (b) YWTV
(c) IHFG (d) NMKL

DIRECTIONS (Qs. 152-159) : In Question, find the odd word/ number letters/number pair from the given alternatives.

- (SSC CHSL 2014)**
152. (a) Chameleon (b) Crocodile
(c) Alligator (d) Locust
153. (a) BCDG (b) GIJL
(c) PRSU (d) UWXZ
154. (a) MKHBD (b) GFKHC
(c) BDFAT (d) XVRPI
155. (a) DCEB (b) PNQST
(c) VKHGM (d) WPZLH
156. (a) 1625 (b) 3649
(c) 6481 (d) 5025
157. (a) 512 (b) 625
(c) 1296 (d) 2401
158. (a) Poland (b) Korea
(c) Spain (d) Greece
159. (a) Polaris (b) Nike
(c) Crux (d) Phoenix

DIRECTIONS (Qs. 160-165) : In questions below, find the odd number/letters/number pair from the given alternatives.

- (SSC Sub. Ins. 2015)**
160. (a) (47,49) (b) (5,7)
(c) (29,31) (d) (11,13)

161. (a) Marigold (b) Lotus
(c) Tulip (d) Rose
162. (a) mmm qqg ttt (b) ccc ggg kkk
(c) kkk ooo sss (d) bbb fff jjj
163. (a) 8110 (b) 1234
(c) 9100 (d) 1189
164. (a) Brass (b) Tin
(c) Bronze (d) Steel
165. (a) TEAP (b) QIEM
(c) HIUL (d) ZOIV

DIRECTIONS (Qs. 166-174) : In question, find the odd word/ letters/number pairs from the given alternatives.

(SSC CHSL 2015)

166. (a) Tea : Beverages (b) Legumes : Nodules
(c) Beans : Pulses (d) Rice : Cereals
167. (a) SRQP (b) LKJI
(c) HGFE (d) UVWX
168. (a) 66 (b) 76
(c) 56 (d) 36
169. (a) SQOM (b) WUSP
(c) MKIG (d) ZXVT
170. (a) DAC (b) UTV
(c) IFH (d) NKM
171. (a) (36,27) (b) (23,14)
(c) (82,29) (d) (45,18)
172. (a) Cone (b) Rectangle
(c) Circle (d) Triangle
173. (a) Knock (b) Wrong
(c) Psychology (d) Fast
174. (a) 3249 (b) 2709
(c) 8314 (d) 2518

DIRECTIONS (Qs. 175-183): Find the odd word/letters/ number pair from the given alternatives.

(SSC CHSL 2015)

175. (a) GLOVES (b) SWEATER
(c) SHAWL (d) UMBRELLA
176. (a) PORTRAIT (b) DRAW
(c) PAINT (d) SKETCH
177. (a) HAND (b) NOSE
(c) MOUTH (d) EYES
178. (a) 6 : 22 (b) 8 : 25
(c) 13 : 40 (d) 15 : 46
179. (a) 21 (b) 81
(c) 71 (d) 51
180. (a) HNOP (b) VUTS
(c) RQPO (d) HGFE
181. (a) D T ST (b) Q37Q
(c) N T OP (d) KZM T
182. (a) 100 (b) 125
(c) 343 (d) 216
183. (a) VXB (b) PSV
(c) DGJ (d) FIL

DIRECTIONS (Qs. 184-186) : Find the Odd Word/Letters/ Numbers from the given alternatives

(SSC CGL 1st Sit. 2016)

184. (a) House (b) Stable
(c) Hut (d) Cottage
185. (a) BDGK (b) JLOS
(c) NPSW (d) MORU
186. (a) 484 (b) 529
(c) 625 (d) 566

DIRECTIONS (Qs. 187-189) : Find the odd words/letter/ numbers from the given alternatives:

(SSC CGL 1st Sit. 2016)

187. (a) A (b) U
(c) T (d) O
188. (a) January (b) April
(c) July (d) May
189. (a) 28-21 (b) 31-38
(c) 45-52 (d) 64-71

DIRECTIONS (Qs. 190-192) : Find the odd word/letters/numbers from the given alternatives:

(SSC CGL 2nd Sit. 2016)

190. (a) Rupee (b) Pound
(c) Yen (d) Currency
191. (a) DAEH (b) KIMP
(c) HEIL (d) FCGJ
192. (a) 43-6 (b) 28-4
(c) 50-7 (d) 36-5

DIRECTIONS (Qs. 193-195) : Find the odd word/letter/ number form the given alternative.

(SSC CGL 2nd Sit. 2016)

193. (a) Rival (b) Opponent
(c) Foe (d) Ally
194. (a) POCG (b) KLIZ
(c) BUDX (d) FQMV
195. (a) 36 - 48 (b) 56 - 44
(c) 78 - 66 (d) 33 - 64

DIRECTIONS (Qs. 196-202) : In the following questions, find the odd word / letters/number pair from the given alternatives.

(SSC Stenographer 2016)

196. (a) Beak (b) Rudder
(c) Wing (d) Fin
197. (a) LCUF (b) JHMX
(c) AKWE (d) PNTQ
198. (a) 99,99 (b) 36,63
(c) 28,82 (d) 24,44
199. (a) RQOP (b) IJSO
(c) CBUV (d) YXTU
200. (a) 79,63 (b) 167,150
(c) 84,67 (d) 112,95
201. (a) Tent (b) Inn
(c) Mansion (d) Lodge
202. (a) Square (b) Triangle
(c) Sphere (d) Circle

DIRECTIONS (Qs. 203-207) : In the following questions, find the odd word/letters/number pair from the given alternatives.

(SSC SI 2016)

203. (a) DFOU (b) NPSW
(c) KMPT (d) DFIM
204. (a) MSY (b) LRX
(c) INU (d) AGM
205. (a) 286 (b) 166
(c) 495 (d) 583
206. (a) Wing Commander (b) Air Marshal
(c) Captain (d) Group Captain
207. (a) 243 - 132 (b) 183 - 54
(c) 108 - 97 (d) 99 - 63

DIRECTIONS (Qs. 208-210) : In the following questions, select the odd word from the given alternatives.

(SSC CGL 2017)

208. (a) Lion (b) Leopard
(c) Snake (d) Tiger
209. (a) NPR (b) TVW
(c) FHJ (d) KMO
210. (a) 69 (b) 59
(c) 61 (d) 53
211. In the following question, select the odd word pair from the given alternatives. (SSC CGL 2017)
(a) Error : Accurate (b) Careless : Casual
(c) Strength : Lethargy (d) Gloomy : Cheerful
212. In the following question, select odd letters from the given alternatives. (SSC CGL 2017)
(a) FUGT (b) KPLO
(c) DWEV (d) CWDX
213. In the following question, select the odd number pair from the given alternatives. (SSC CGL 2017)
(a) 11 - 120 (b) 17 - 290
(c) 21 - 442 (d) 12 - 145

DIRECTIONS (Qs. 214-216) : In the following question, select the odd word from the given alternatives.

214. (a) Chennai (b) Daman (SSC CGL 2017)
(c) Raipur (d) Shimla
215. (a) B (b) N
(c) P (d) W
216. (a) 313 (b) 426
(c) 925 (d) 1034
217. In the following question, select the odd word from the given alternatives. (SSC CGL 2017)
(a) Ludo (b) Chess
(c) Polo (d) Carrom
218. In the following question, select the odd letters from the given alternatives. (SSC CGL 2017)
(a) DGJ (b) KNQ
(c) RUX (d) ILN
219. In the following question, select the odd number from the given alternatives. (SSC CGL 2017)
(a) 31 (b) 37
(c) 43 (d) 49

DIRECTIONS (Qs. 220-223): Choose the odd word/letters number/number pair from the given alternatives.

(SSC CHSL 2017)

220. (a) Sirius (b) Proximacentauri
(c) Deimos (d) Alpha centauri
221. (a) PON (b) SRQ
(c) XYZ (d) VUT
222. (a) 1919 (b) 5656
(c) 6761 (d) 7760
223. (a) 2890 (b) 3375
(c) 1728 (d) 1331

DIRECTIONS (Qs. 224-226): Find the odd number/ letters/ word from the given alternatives.

(SSC MTS 2017)

224. (a) HIVW (b) FGKL
(c) ACDF (d) TUOP
225. (a) Cricket (b) Chess
(c) Football (d) Hockey
226. (a) 23 (b) 17
(c) 13 (d) 63

DIRECTIONS (Qs. 227-232) : In the following question, select the odd word from the given alternatives.

(SSC Sub. Ins. 2017)

227. (a) Newspaper (b) Journal
(c) Novel (d) Magazine
228. (a) Definite (b) Specific
(c) Doubtful (d) Distinct
229. (a) BEHK (b) JMPS
(c) PSVY (d) EHKM
230. (a) AD (b) PT
(c) EH (d) JM
231. (a) 12 - 48 (b) 7 - 28
(c) 5 - 20 (d) 11 - 55
232. (a) 12 - 28 (b) 20 - 36
(c) 42 - 58 (d) 72 - 90

DIRECTIONS (Qs. 233 - 239) : In the following question, select the odd number pair from the given alternatives.

(SSC Steno. 2017)

233. (a) 7 - 50 (b) 11 - 122
(c) 15 - 226 (d) 13 - 168
234. (a) 7 - 56 (b) 10 - 110
(c) 9 - 90 (d) 8 - 96
235. (a) KM (b) PR
(c) TV (d) EH
236. (a) RQP (b) LKJ
(c) HGF (d) ECB
237. (a) Sward (b) Spear
(c) Gun (d) Dagger
238. (a) Brown - Colour (b) Rice - Grain
(c) Fan - Air (d) Iron - Metal

239. (a) Cry - Laugh (b) Up - Down
(c) Increase - Decrease (d) Walking - Running
240. Three of the following four words are alike in a certain way and one is different. Pick the odd word out. **(SSC CGL 2018)**
(a) Big (b) Expensive
(c) Costly (d) Valuable
241. Three of the following four number-pairs are alike in a certain way and one is different. Pick the odd one out. **(SSC CGL 2018)**
(a) 56:49 (b) 64:54
(c) 104:91 (d) 32:28
242. Three of the following four letter - clusters are alike in a certain way and one is different. Pick the odd one out. **(SSC CGL 2018)**
(a) POWZ (b) KNQT
(c) FILO (d) QTWZ
243. Three of the following four number-pairs are alike in a certain way and one is different. Pick the odd pair out. **(SSC CGL 2018)**
(a) 4 : 27 (b) 49 : 218
(c) 16 : 125 (d) 9 : 64
244. Three of the following four letter-clusters are alike in a certain way and one is different. Pick the odd one out **(SSC CGL 2018)**
(a) RVZDG (b) DHLPT
(c) UYCGK (d) AEIMQ
245. Three of the following four words are alike in a certain way and one is different. Pick the odd word out. **(SSC CGL 2018)**
(a) Indigo (b) Silver
(c) Orange (d) Violet
246. Three of the following four letter-clusters are alike in a certain way and one is different. **(SSC CHSL 2018)**
Pick the odd one out.
(a) CGK (b) LPT
(c) BFM (d) NRV
247. Three of the following four words are alike in a certain way and one is different. **(SSC CHSL 2018)**
Pick the odd word out.
(a) Disaster (b) Storm
(c) Cyclone (d) Flood
248. Three of the following four numbers are alike in a certain way and one is different. Pick the number that is different from the rest. **(SSC CHSL 2018)**
(a) 16 (b) 121
(c) 100 (d) 81
249. Three of the following four words are alike in a certain way and one is different. Find the odd one out. **(SSC Sub. Ins. 2018)**
(a) Moon (b) Mars
(c) Mercury (d) Venus
250. Three of the following four words are alike in a certain way and one is different. Find the odd one out. **(SSC Sub. Ins. 2018)**
(a) Hexagon (b) Ellipse
(c) Parallelogram (d) Rhombus
251. Three of the following four number-pairs are alike in a certain way and one is different. Find the odd one out. **(SSC Sub. Ins. 2018)**
(a) 345 : 678 (b) 456 : 798
(c) 123 : 456 (d) 234 : 567
252. Three of the following four letter-clusters are alike in a certain way and one is different. Find the odd one out. **(SSC Sub. Ins. 2018)**
(a) TVUW (b) BFDH
(c) KQNT (d) HPKM
253. Three of the following four number-pairs are alike in a certain way and one is different. Find the odd one out. **(SSC Sub. Ins. 2018)**
(a) 24 : 42 (b) 48 : 84
(c) 56 : 75 (d) 36 : 63
254. Three of the following four number-pairs are alike in a certain way and one is different. Find the odd one out. **(SSC Sub. Ins. 2018)**
(a) 7 : 11 (b) 11 : 25
(c) 9 : 17 (d) 13 : 29
255. Three of the following four number-pairs are alike in a certain way and one is different. Find the odd one out. **(SSC Sub. Ins. 2018)**
(a) 25 : 50 (b) 36 : 63
(c) $\hat{9} : \hat{26}$ (d) $\hat{49} : \hat{82}$
256. Three of the following four letter-clusters are alike in a certain way and one is different. Find the odd one out. **(SSC Sub. Ins. 2018)**
(a) QSUW (b) MNOQ
(c) BDFH (d) EGIK
257. Four pairs of words have been given, out of which three are alike in some manner, while one is different. Choose out the odd one. **(SSC Stenographer 2018)**
(a) Photo : Frame (b) House : Compound wall
(c) Garden : Fence (d) Room : Door
258. Four words have been given out of which three are alike in some manner, while one is different. Choose the odd one. **(SSC Stenographer 2018)**
(a) Fenugreek (b) Coccinia
(c) Amaranth (d) Spinach
259. Find the odd letter cluster. **(SSC Stenographer 2018)**
(a) NM (b) BD
(c) IR (d) PK
260. Four words have been given out of which three are alike in some manner, while one is different. Choose the odd one. **(SSC Stenographer 2018)**
(a) Carbohydrates (b) Enzymes
(c) Proteins (d) Vitamins
261. Four pairs of numbers have been given, out of which three are alike in some manner, while one is different. Choose out the odd one. **(SSC Stenographer 2018)**
(a) 4925 : 35 (b) 1625 : 9
(c) 4964 : 15 (d) 1681 : 13

262. Four words have been given out of which three are alike in some manner, while one is different. Select the odd word.
(SSC CGL 2019-20)
- (a) Ferry (b) Submarine
(c) Ship (d) Yacht
263. Four letter-clusters have been given, out of which three are alike in some manner, while one is different. Select the odd
(SSC CGL 2019-20)
- (a) DWIR (b) BYGT
(c) NMSH (d) FVKO
264. Four letter-clusters have been given, out of which three are alike in some manner and one is different. Select the odd letter-cluster.
(SSC CHSL 2019-20)
- (a) TSRQ (b) PONL
(c) MLKJ (d) WVUT
265. Four words have been given, out of which three are alike in some manner and one is different. Select the word that is different.
(SSC CGL 2020-21)
- (a) Mumbai (b) Raipur
(c) Ranchi (d) Ahmedabad
266. Select the number-pair in which the two numbers share a different relationship from that shared by the two numbers in the rest of the number-pairs.
(SSC CGL 2020-21)
- (a) (215, 338) (b) (11, 134)
(c) (169, 292) (d) (178, 308)
267. Four letter-clusters have been given, out of which three are alike in some manner and one is different. Select the letter-cluster that is different.
(SSC CGL 2020-21)
- (a) TYDI (b) HMRW
(c) ZEJP (d) NSXC
268. Four letter-clusters have been given, out of which three are alike in some manner and one is different. Select the letter-cluster that is different.
(SSC CHSL 2020-21)
- (a) VBHN (b) AGMS
(c) IPVA (d) HNTZ
269. Three of the following four words are alike in a certain way and one is different. Select the odd one.
(SSC CHSL 2020-21)
- (a) Liver (b) Heart
(c) Nose (d) Lungs
270. Four number-pairs have been given, out of which three are alike in some manner and one is different. Select the number-pair that is different.
(SSC CHSL 2020-21)
- (a) 5 : 35 (b) 19 : 324
(c) 7 : 63 (d) 13 : 195
271. Three of the following four letter-cluster pairs are alike in a certain way and one is different. Pick the odd one out.
(SSC Stenographer 2020-21)
- (a) MAGIC : AMGCI (b) FIRST : IFRTS
(c) LOGIC : OLGCI (d) CREST : RCTES
272. Three of the following four letter-cluster are alike in a certain way and one is different. Pick the odd one out.
(SSC Stenographer 2020-21)
- (a) GIOV (b) WZFL
(c) SVAH (d) CFKR
273. Three of the following four letter-clusters are alike in a certain way and one is different. Pick the odd one out.
(SSC Sub-Inspector 2020-21)
- (a) OMSVY (b) ORUXA (c) CFILO (d) UXADG
274. Three of the following four letter-clusters are alike in a certain way and one is different. Pick the odd one out.
(SSC Sub-Inspector 2020-21)
- (a) UFAL (b) DWJC (c) BYHE (d) HSNZ

Hints & Solutions

1. (d) Except the number pair 9, 64 in all others perfect squares of two consecutive numbers are given.
- | | |
|-------------------|-------------------|
| 25 | 36 |
| ↓ | ↓ |
| (5) ² | (6) ² |
| 144 | 169 |
| ↓ | ↓ |
| (12) ² | (13) ² |
| 100 | 121 |
| ↓ | ↓ |
| (10) ² | (11) ² |
- But,
- | | |
|------------------|------------------|
| 9 | 64 |
| ↓ | ↓ |
| (3) ² | (8) ² |
2. (c) Bulb is an item while all others are phenomena.
3. (c) Except Tide, all other terms are related to both air and water. But tide is a regular rise and fall in the level of sea, caused by the attraction of the moon and sun.
4. (b) The position number of Y in the English alphabet is an odd number.
- X ⇒ 24, Y ⇒ 25
H ⇒ 8, D ⇒ 4
5. (d)
- | | | | | | | | |
|---|---|----|---|---|---|----|---|
| Z | K | X | J | C | M | A | L |
| | | -1 | | | | -1 | |
| | | ↓ | | | | ↓ | |
| | | | | | | | |
| | | -2 | | | | -2 | |
| | | ↑ | | | | ↑ | |
-
- | | | | | | | | |
|---|---|----|---|---|---|-----|---|
| T | G | R | F | F | R | T | K |
| | | -1 | | | | -7 | |
| | | ↓ | | | | ↓ | |
| | | | | | | | |
| | | -2 | | | | +14 | |
| | | ↑ | | | | ↑ | |
6. (c) Except in letter group IXYOQ, in all others there is only one vowel.
- In the letter group IXYOQ, there are two vowels.
7. (c) Except Veranda, all others are surrounded by four walls.
8. (d) Except Sonata, all others are instruments. Sonata is a piece of music composed for one instrument or two.

9. (c) Except D, all others are Vowels.
10. (c) Here, $R \xrightarrow{-4} N \xrightarrow{-1} M \xrightarrow{+3} P$
 $J \xrightarrow{-4} F \xrightarrow{-1} E \xrightarrow{+3} H$
 $R \xrightarrow{-2} P \xrightarrow{-1} O \xrightarrow{+2} Q$
 $H \xrightarrow{-4} D \xrightarrow{-1} C \xrightarrow{+3} F$
11. (c) Except in ApqrL, in all others the first and the last letters given in capital are vowels.
12. (d) $6 + 2 = 8, 4 + 3 = 7 \Rightarrow 8 - 7 = 1$
 $2 + 6 = 8, 4 + 3 = 7 \Rightarrow 8 - 7 = 1$
 $8 + 4 = 12, 6 + 5 = 11 \Rightarrow 12 - 11 = 1$
 $4 + 8 = 12, 6 + 7 = 13 \Rightarrow 12 - 13 = -1$
13. (d) $49 - 33 = 16, 62 - 46 = 16$
 $83 - 67 = 16$ But, $70 - 55 = 15$
14. (a) Except Flute, all others are stringed musical instruments.
15. (b) **Prod (Verb)** means, 'to push somebody/something with a finger or a pointed object', 'to encourage', 'to poke'.
Prod (Noun) means 'an act of prodding', 'an act of reminding somebody to take action'.
Sap (Verb) means 'to make somebody/something weak or destroy gradually'.
Sap (Noun) means 'the liquid in a plant that carries food to all parts of it', 'a stupid person who is easily tricked or treated unfairly'.
Jab (Verb) means 'to push or poke at somebody/something quickly and roughly'.
Jab (Noun) means 'a sudden rough blow'.
Thrust (Verb) means 'to push something/somebody/oneself suddenly or violently'.
Thrust (Noun) means 'an act or movement of thrusting'.
Therefore, Sap is different from others.

16. (b) Except MNST, all others are having a vowel.
17. (b) TSWV does not have any vowel

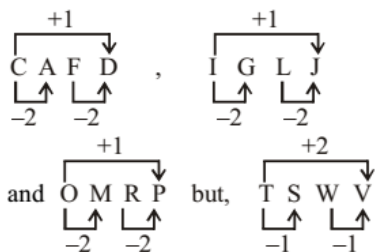

So, TSWV is odd one out.

18. (d) As, $162 \Rightarrow 16 \div 2 = 8$
 $405 \Rightarrow 40 \div 5 = 8,$
and $567 \Rightarrow 56 \div 7 = 8,$
but, $644 \Rightarrow 64 \div 4 = 16$
19. (a) Except 156, all other numbers are odd numbers.
20. (a) $\frac{115}{11} = 10.45; \frac{90}{10} = 9; \frac{72}{9} = 8; \frac{56}{8} = 7$
21. (d) Basketball is different from others. In Softball, Baseball and Cricket, bats and balls are used, Basketball involves only ball.

22. (d) Ravage is the different from the other words.
23. (a) Here,

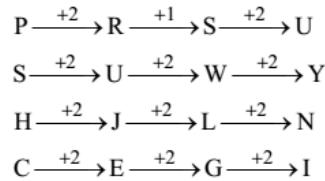

24. (c) Here,

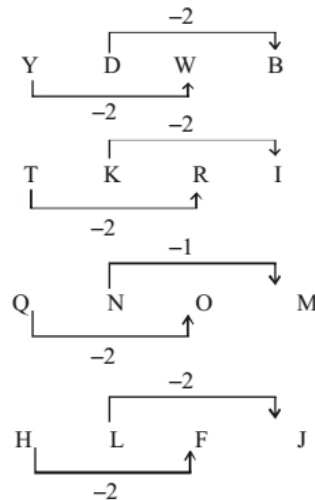

25. (a) Except Tomato all others are grown underground.

26. (a) The number 125 is a perfect cube.

$$5 \times 5 \times 5 = 125$$

27. (d) As $2 \times 8 = 16; 2 \times 9 = 18$

$$7 \times 8 = 56; 7 \times 9 = 63$$

$$12 \times 8 = 96; 12 \times 9 = 108$$

$$\frac{86}{8} = 10.75; \frac{99}{9} = 11$$

Also, only (d) is coprime.

28. (b) $S \xrightarrow{-3} P$

$$N \xrightarrow{-2} L$$

$$Z \xrightarrow{-3} W$$

$$T \xrightarrow{-3} Q$$

29. (d) Major, Colonel and Brigadier are different ranks in the Indian Army. Admiral is the topmost rank in the Indian Navy.

30. (a) Except Life Insurance Corporation, all others are insurance companies for general insurance, i.e., for vehicles, property etc.

31. (b) Except disease, all other terms denote obstruction, hindrance or interruption.

32. (b) Except remedy, all other terms denote loss of something.

33. (a) Socrates was a Greek philosopher. Ludwig Van Beethoven was a German Composer and Musician. Bach was also a German Composer. WA Mozart was a Austrian Compose.

34. (d) 112 is completely divisible by 4.

$$\frac{112}{4} = 28; \frac{132}{5} = 26.4; \frac{125}{8} = 15.625; \frac{124}{7} = 17.71$$

35. (a) The difference between the two numbers in the number pair 6246 – 6296 is least.
 $6296 - 6246 = 50$
 $7267 - 7137 = 130$
 $4684 - 4344 = 340$
 $5465 - 5235 = 230$
36. (b) 81 is a perfect square.
37. (c) Except in (216, 02), in all others both the numbers are perfect cubes.
38. (c) Except Subtract, all others are Nouns. The Noun for subtract (Verb) is Subtraction.
39. (c) 27 is a perfect cube. All other numbers are Prime Numbers.
40. (b) $1 + 8 + 6 = 15$ and $6 + 9 = 15$
41. (d) Except in the number 28751, in all others the digits are the same.
42. (a) IVEF \Rightarrow FIVE
 VEENS \Rightarrow SEVEN
 EINN \Rightarrow NINE
 VEIIDD \Rightarrow DIVIDE
43. (a) Jammu and Kashmir, Haryana and Himachal Pradesh are northern States of India. Arunachal Pradesh is eastern-most States of India.
44. (b) Number is different from the others.
45. (b) Frog is an amphibian.
46. (d) Except Agenda, all other denotes a group of persons.
47. (d) $V \xrightarrow{+1} W \xrightarrow{+2} Y$
 $Q \xrightarrow{+1} R \xrightarrow{+2} T$
 $L \xrightarrow{+1} M \xrightarrow{+2} O$
 But, $J \xrightarrow{+1} K \xrightarrow{+1} L$
48. (a) Only BE has a vowel
49. (d) Except the number 729, all others are only perfect squares.
50. (b) Except the number 1725, all other numbers are completely divisible by 4. The number 1725 is completely divisible by 5.
 $\frac{1000}{4} = 250$; $\frac{2744}{4} = 686$; $\frac{4096}{4} = 1024$
 But, $\frac{1725}{5} = 345$
51. (c) Except the number pair 30 – 50, all other numbers pairs has ratio = $\frac{3}{4}$
52. (d) Except LR, all others are pairs of opposite letters.
 $C \leftrightarrow X$; $D \leftrightarrow W$;
 $J \leftrightarrow Q$
 $L \leftrightarrow O$ (Not R)
53. (a) Except Cyclotron, all others are languages of computer. Cyclotron is an apparatus in which charged atomic and subatomic particles are accelerated by an alternating electric field while following an outward spiral or circular path in a magnetic field.
54. (b) Rooster, Gander and Peahen are birds. Buck is an animal.
55. (c) Except Voucher, all others are small book containing information on a specific subject. Voucher is a small printed piece of paper which can be exchanged for certain goods and services.
56. (b) As, all terms given in question are medical terms except geology.
57. (d) Pond is an area filled with water.
58. (d) All except Ellora are famous for temples, while Ellora is famous for caves.
59. (a) Consonants and vowel are used in option (b), (c) and (d). Only consonants are used in option (a).
60. (b) $\begin{array}{ccc} E & F & H \\ \boxed{+1} \uparrow & \boxed{+2} \uparrow & \\ B & C & E \\ \boxed{+1} \uparrow & \boxed{+2} \uparrow & \end{array}$ $\begin{array}{ccc} O & P & Q \\ \boxed{+1} \uparrow & \boxed{+1} \uparrow & \\ I & J & L \\ \boxed{+1} \uparrow & \boxed{+2} \uparrow & \end{array}$
61. (c) $\begin{array}{cccccc} D & H & F & J & H & K & P & R \\ \downarrow & \downarrow & \downarrow & \downarrow & \downarrow & \downarrow & \downarrow & \downarrow \\ 4 & 8 & 6 & 10 & 8 & 11 & 16 & 18 \\ & & & & \boxed{8} & \boxed{11} & & \end{array}$
 Pair of odd and even number
62. (b) $24 = 5^2 - 1$ $80 = 9^2 - 1$
 $49 = 7^2 - 0$ $15 = 4^2 - 1$
63. (c) All are squares except (c).
64. (d) $704 \div 11 = 64$ $256 \div 4 = 64$
 $832 \div 13 = 64$ $310 \div 5 = 62$
65. (d) Except (d), All (a), (b) and (c) are synonyms of bird.
66. (a) Except (a), All (b), (c) and (d) are forms of digging.
67. (a) Except (a), other can be written in form of x^3 .
68. (c)
69. (c) The first and last are vowels.
70. (d) Options (a), (b) and (c) are related to human beings but option (d) represents insects.
71. (d) One small letter is followed by capital letter but in option (d), the first letter is not vowel while in others first letter is vowel.
72. (c) Except (c), all other options represents pairs of consecutive numbers.
 E.g. $\begin{array}{ccc} 1, & 2, & 4, & 5 \\ \boxed{+1} \uparrow & \boxed{+1} \uparrow & & \end{array}$ \therefore (c) is odd one out.
73. (c) All are parts of car.
74. (d) All are divisible by 5 except 256.
75. (a) $\begin{array}{cccc} N & L & M & Y \\ \swarrow +1 & \searrow +1 & \swarrow +1 & \searrow +1 \\ X & M & Y & Z \\ \swarrow +1 & \searrow +1 & \swarrow +1 & \searrow +1 \\ Z & N & M & O \\ \swarrow +1 & \searrow +1 & \swarrow +1 & \searrow +1 \\ O & R & Q & S \end{array}$
76. (d) All are planets except sun.
77. (b) $12 \xrightarrow{\times 4} 48$; $18 \xrightarrow{\times 3} 54$; $16 \xrightarrow{\times 4} 64$;
 $14 \xrightarrow{\times 4} 56$
78. (a) $\begin{array}{ccc} \boxed{+4} \downarrow & \boxed{+4} \downarrow & \boxed{+4} \downarrow & \boxed{+3} \downarrow \\ C & J & G, & S & Z & W & \text{and} & P & W & T & \text{but} & L & R & O \\ \boxed{+3} \uparrow & \boxed{+3} \uparrow & & \boxed{+3} \uparrow & \boxed{+3} \uparrow & & \boxed{+3} \uparrow & \boxed{+3} \uparrow & \end{array}$
79. (d) Yen is the currency of Japan, an Asian country. Pound (Sterling), Deutsche Mark and Franc are currencies of European countries.

80. (b) Red, Green and Blue are called primary colours or basics colours.
Red + Green \Rightarrow Yellow colour Except in option (b), in all others there is one primary colour.
81. (d) Agreeable is different from the other three words.
Agreeable (Adjective) means 'pleasant', 'giving pleasure', ready to agree'.
Firm (Adjective) means 'not yielding when pressed', 'fairly hard', 'definite', 'not likely to change' etc.
Grave (Adjective) means 'serious and important', 'giving cause for worry'.
Fastidious (Adjective) means 'selecting carefully', 'hard to please', 'easily disgusted' etc.
82. (c) $27 = 3 \times 3 \times 3$
 $125 = 5 \times 5 \times 5$
 $216 = 6 \times 6 \times 6$
 $343 = 7 \times 7 \times 7$
The number 216 is a perfect cube of an even number.
83. (d) Except Agra, all others are hill stations.
84. (b) Foal is the young one of a horse or of a related animal.
Lamb is the young one of the sheep.
Leveret is the young one of a hare.
Hen is a female bird especially of a fowl.
85. (c) Here,

$$B \xrightarrow{-1} A \xrightarrow{+3} D \xrightarrow{-1} C$$

$$X \xrightarrow{-1} W \xrightarrow{+3} Z \xrightarrow{-1} Y$$

$$V \xrightarrow{-1} U \xrightarrow{-2} S \xrightarrow{+1} T$$

$$N \xrightarrow{-1} M \xrightarrow{+3} P \xrightarrow{-1} O$$
86. (d) Here,

$$D \xrightarrow{-1} C \xrightarrow{+3} F \xrightarrow{+1} G$$

$$F \xrightarrow{-1} E \xrightarrow{+3} H \xrightarrow{+1} I$$

$$J \xrightarrow{-1} I \xrightarrow{+3} L \xrightarrow{+1} M$$

$$H \xrightarrow{-1} G \xrightarrow{+3} J \xrightarrow{+2} L$$
87. (b) In the number pair (2, 3) both the numbers are prime numbers.
88. (d) Except the number pair (82, 64), in all other number pairs both the numbers are multiples of 3.
 $96 = 32 \times 3$; $24 = 8 \times 3$
 $39 = 13 \times 3$; $18 = 6 \times 3$
 $81 = 27 \times 3$; $54 = 18 \times 3$
89. (c) Except Influenza, all others are diseases caused by deficiency of vitamins while, influenza is caused by virus.
90. (c) Except Raisin, all others are different forms of precipitation.
91. (c) $248 - 231 = 17$
 $563 - 547 = 16$
 $71 - 55 = 16$
 $523 - 517 = 06$
Except in the option (c), in all other number pairs, the difference between the two numbers is an even number.
92. (c) $10 \Rightarrow 1 + 0 = 1$
 $13 \Rightarrow 1 + 3 = 4$
 $234 \Rightarrow 2 + 3 + 4 = 9$
- $681 \Rightarrow 6 + 8 + 1 = \boxed{15}$
 $997 \Rightarrow 9 + 9 + 7 = 25$
Consecutive square numbers are given.
93. (d) Except in the word Led, in all other words there are two vowels.
94. (c) Fervent: having or displaying a passionate intensity.
Enthusiastic: having or showing intense and eager enjoyment.
Ardent: very enthusiastic or passionate
Apathetic: showing or feeling no interest, enthusiasm or concern.
Hence, apathetic is odd one out.
95. (a) In all other groups, a vowel is followed by a consonant repeated twice.
96. (a) Only 117-143 is divisible by 13. Therefore, it is odd one out.
97. (d) Radio, Transistor and television are the way of broadcasting. Hence, tube is odd one out.
98. (b) Barrack is a large building or group of buildings where soldiers live.
Principal is the head of school. Troupe is a group of artists.
Chorous is a large group of singers.
99. (a) 'Detach' is different from the other three words.
Detach means 'to separate or remove something from a larger or longer part'.
Affix means 'to stick, fasten or attach something'.
Append means 'to attach or add something'.
100. (d) M a n

$$\begin{array}{ccc} \downarrow & \downarrow & \downarrow \\ 13 & 1 & 14 \end{array}$$

The position number of letters in the English alphabet.

R	a	m	J	u	g	H	u	b
\downarrow	\downarrow	\downarrow	\downarrow	\downarrow	\downarrow	\downarrow	\downarrow	\downarrow
18	1	13	10	21	7	8	21	2
101. (b) The second number in each number is the first digit of the first number.
The difference between the two digits of the first number is 3 in all the number pairs except 97, 9.
102. (b) Except (b) all others are males.
103. (d) Except (d) all others are in backward order.
104. (a) All are vowels in 'AIUE'
105. (d) Only 322 is an even number.
106. (c) Rest are not perfect square.
107. (a) Teaching is different from the other three words.
108. (c) Except in the number pair (7, 169) in all other number pairs both the numbers are perfect squares.
 $(25, 49) \Rightarrow [(5)^2, (7)^2]$
 $(121, 169) \Rightarrow [(11)^2, (13)^2]$
 $(9, 25) \Rightarrow [(3)^2, (5)^2]$
109. (c) In the word MEET, the second and the third letters are the same.
110. (b) $8465 \Rightarrow 84 - 65 = 19$
 $2643 \Rightarrow 43 - 26 = 17$
 $4867 \Rightarrow 67 - 48 = 19$
 $6243 \Rightarrow 62 - 43 = 19$

111. (c) $F \xrightarrow{+2} h \xrightarrow{+2} j \xrightarrow{+2} L$
 $P \xrightarrow{+2} r \xrightarrow{+2} t \xrightarrow{+2} V$
 $K \xrightarrow{+3} n \xrightarrow{+2} p \xrightarrow{+2} R$
 $C \xrightarrow{+2} e \xrightarrow{+2} g \xrightarrow{+2} I$
112. (b) Violin is a musical instrument with four strings of treble pitch played with a bow.
113. (d) All (a) (b) and (c) are the type of noun.
114. (d) Second number is a square of first number. i.e., $5:(5)^2$, $8:(8)^2$, $7:(7)^2$. Therefore, 6:30 is odd one out.
115. (c) Sum of all digits of given numbers are 11. But option (c) shows the sum '12'. Therefore, it is odd one out.
116. (a)
117. (b) Except (b) others are creators.
118. (b) Except (b), vowel is present.

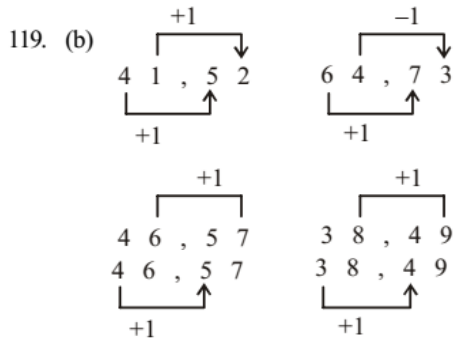

120. (a) Hexagon not made from angle.
121. (b) Only football doesn't require the use of handheld apparatus.
122. (b) Only in TV we can see picture and listen to the voice.
123. (b) (a) $C \xrightarrow{+1} D \xrightarrow{+2} F \xrightarrow{-1} E$
 (b) $R \xrightarrow{+1} S \xrightarrow{+1} T \xrightarrow{+2} V$ → odd one out
 (c) $J \xrightarrow{+1} K \xrightarrow{+2} M \xrightarrow{-1} L$
 (d) $M \xrightarrow{+1} N \xrightarrow{+2} P \xrightarrow{-1} O$
124. (a) Except (a) in all other pairs second term is reverse order of first term.
125. (d) Except (d) all other have even numbers.

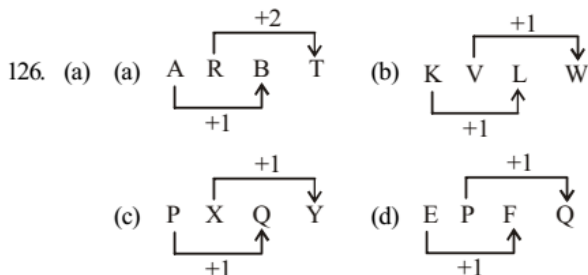

127. (d) An *Obsterician* is a medical doctor who specializes in the management of pregnancy, labor and birth.
 A *Podiatrist* is a doctor who diagnose and treat conditions of the foot, ankle, and related structures of the leg.
 A *Pulmonologist* is a physician who possesses specialised knowledge and skill in the diagnosis and treatment of lung conditions and disease.

A *Prosthetist* is a device designed to replace a missing part of the body or to make a part of body work better. Hence (d) is odd one out.

128. (b) Except (b), all other are related to a period. While decadent is a person who has interest only in pleasure and enjoyment.
129. (b) Except (b) all others have consecutive letters in reverse order.
 While (b) has consecutive letters in forward order.
130. (b) Except (b) all others have five letters.
131. (d) Except (d) in both number in all others pairs are divided by same number.
132. (d) Except (d) All others have odd numbers.
133. (d) Except (d), all others belong to the period of before sunset.
134. (b) Except (b), all others are principles of society.
135. (a) Option (b):

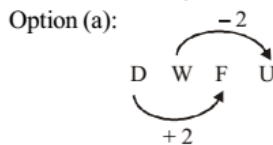
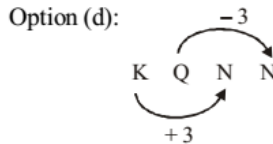
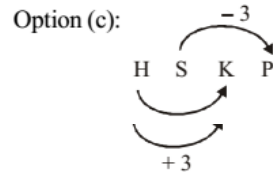
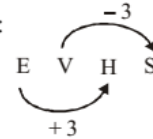

Hence, option (a) is the group of odd letters.

136. (d) Option (a): $C \xrightarrow{-1} B \xrightarrow{+3} E \xrightarrow{+1} F$
 Option (b): $E \xrightarrow{-1} D \xrightarrow{+3} G \xrightarrow{+1} H$
 Option (c): $I \xrightarrow{-1} H \xrightarrow{+3} K \xrightarrow{+1} L$
 Option (d): $G \xrightarrow{-1} F \xrightarrow{+2} H \xrightarrow{+2} J$
 Hence, option (d) is the odd group of letters.
137. (d) $4+0+2+5=11$
 $6+0+2+3=11$
 $7+2+0+2=11$
 $5+0+6+1=12$
 Hence, (d) is the odd one out.

138. (a)
- | | | |
|--------|---|--------|
| 64 | : | 48 |
| ↓ | | ↓ |
| (8×8) | | (8×6) |
| 80 | : | 60 |
| ↓ | | ↓ |
| (10×8) | | (10×6) |
| 104 | : | 78 |
| ↓ | | ↓ |
| (13×8) | | (13×6) |

Hence, option (a) is odd one out

139. (a) All others except (a) have official rankings
 140. (b) All other except (b) are forms of angles
 141. (c) All others except (c) are the multiples of 5.
 142. (b) Only in option (b) first letter is 4th from the left end and second letter is 4th from the right end. Others have no sequence
 143. (b) All except 'PERU' have vowel in both ends.
 144. (d) 1331 is the cube of 11
 145. (b)
 146. (d)
 147. (d) Except (d) all others are divided by 17.
 148. (d) Except (d) in all others second number is divisible by the first one.
 149. (b) Except (b) all others are divisible by 7.
 150. (c) Except (b) others are connected with a job that needs special skill, while school is an organisation.
151. (b) (a) $S \xrightarrow{-1} R \xrightarrow{-2} P \xrightarrow{+1} Q$
 (b) $Y \xrightarrow{-2} W \xrightarrow{-3} T \xrightarrow{+2} V$ odd one out
 (c) $I \xrightarrow{-1} H \xrightarrow{-2} F \xrightarrow{+1} G$
 (d) $N \xrightarrow{-1} M \xrightarrow{-2} K \xrightarrow{+1} L$
152. (d) Except (d) all others are reptiles.
 While locust is a large insect.
153. (a) $B \xrightarrow{+1} C \xrightarrow{+1} D \xrightarrow{+3} G \rightarrow$ odd one
 $G \xrightarrow{+2} I \xrightarrow{+1} J \xrightarrow{+2} L$
 $P \xrightarrow{+2} R \xrightarrow{+1} S \xrightarrow{+2} U$
 $U \xrightarrow{+2} W \xrightarrow{+1} X \xrightarrow{+2} Z$
154. (d)
 155. (a) Except (a) all others have five letters.
 156. (d) By going options:
 (a) $16 \quad 25$
 $\downarrow \quad \downarrow$
 $4 \times 4 \quad 5 \times 5$
 (b) $36 \quad 49$
 $\downarrow \quad \downarrow$
 $6 \times 6 \quad 7 \times 7$
 (c) $64 \quad 81$
 $\downarrow \quad \downarrow$
 $8 \times 8 \quad 9 \times 9$
157. (a) Except (a) all others are squares.
 $25^2 = 625$
 $36^2 = 1296$
 $49^2 = 2401$
158. (b) Except (b) all others are countries in Europe while Korea is situated in East Asia.
 159. (b) Except (b) all others mean the central point.
 160. (a) All others except (a) are prime numbers.
 161. (b) Lotus grows in the water but rest grow on the land.

162. (a) (a) $mmm \xrightarrow{+4} qq \xrightarrow{+3} ttt$ (b) $ccc \xrightarrow{+4} ggg \xrightarrow{+4} kkk$
 (c) $kkk \xrightarrow{+4} ooo \xrightarrow{+4} sss$ (d) $bbb \xrightarrow{+4} fff \xrightarrow{+4} jjj$
 Hence (a) is the odd one out.
163. (d) (a) $8 + 1 + 1 + 0 = 10$
 (b) $1 + 2 + 3 + 4 = 10$
 (c) $9 + 1 + 0 + 0 = 10$
 (d) $1 + 1 + 8 + 9 = 19$
 Hence, (d) is the odd one out.
164. (b) Tin is element but rest are the alloys.
 165. (c) HIUL
 166. (b) Tea is a type of beverage, rice is type of cereal and beans is a type of pulse but nodule is source of nitrogen for legume plant.
167. (d) $S \frac{3}{4} \frac{3}{4} \textcircled{R} R \frac{3}{4} \frac{3}{4} \textcircled{Q} Q \frac{3}{4} \frac{3}{4} \textcircled{P}$
 $L \frac{3}{4} \frac{3}{4} \textcircled{K} K \frac{3}{4} \frac{3}{4} \textcircled{J} J \frac{3}{4} \frac{3}{4} \textcircled{I}$
 $H \frac{3}{4} \frac{3}{4} \textcircled{G} G \frac{3}{4} \frac{3}{4} \textcircled{F} F \frac{3}{4} \frac{3}{4} \textcircled{E}$
 But $U \frac{3}{4} \frac{3}{4} \textcircled{V} V \frac{3}{4} \frac{3}{4} \textcircled{W} W \frac{3}{4} \frac{3}{4} \textcircled{X}$
 So, UVWX is odd set of letters.
168. (d) 66, 76 and 56 are not complete squares while 36, is complete square.
169. (b) $S \frac{3}{4} \frac{3}{4} \textcircled{Q} Q \frac{3}{4} \frac{3}{4} \textcircled{O} O \frac{3}{4} \frac{3}{4} \textcircled{M}$
 $M \frac{3}{4} \frac{3}{4} \textcircled{K} K \frac{3}{4} \frac{3}{4} \textcircled{I} I \frac{3}{4} \frac{3}{4} \textcircled{G}$
 $Z \frac{3}{4} \frac{3}{4} \textcircled{X} X \frac{3}{4} \frac{3}{4} \textcircled{V} V \frac{3}{4} \frac{3}{4} \textcircled{T}$
 But, WUSP does not follow this pattern.
170. (b) $D \frac{3}{4} \frac{3}{4} \textcircled{A} A \frac{3}{4} \frac{3}{4} \textcircled{C}$
 $I \frac{3}{4} \frac{3}{4} \textcircled{F} F \frac{3}{4} \frac{3}{4} \textcircled{H}$
 $N \frac{3}{4} \frac{3}{4} \textcircled{K} K \frac{3}{4} \frac{3}{4} \textcircled{M}$
 But UTV, does not follow this pattern.
171. (c) 36, 27 Sum of digits in both is 9
 23, 14 Sum of digits in both is 5
 45, 18 Sum of digits in both is 9
 But, in (82, 29) sum of digits is different.
172. (a) Rectangles, circle and triangle are two-dimensional of figures while cone is a 3-d figure.
 173. (d) In all other except (d) first letter is silent.
 174. (c) In all number except 8314, the sum of first three digits is equal to the unit's digit.
 175. (d) Gloves, Sweater, shawl are worn in winter season while umbrella is used in rainy season.
 176. (a) We used to draw, sketch or paint a portrait.
 177. (a) Nose, Eyes and mouth are in upper portion of body while hands are in lower portion.
 178. (a) $8 \times 3 + 1 = 25$ So 8 : 25
 $13 \times 3 + 1 = 40$ So 13 : 40
 $15 \times 3 + 1 = 46$ So 15 : 46
 But $6 \times 3 + 1 = 19 \neq 22$
 So 6 : 22 is odd

179. (c) 21, 81 and 51 are composite number while 71 is prime number.
180. (a) RQPO, VUTS and HGFE are set of 4 consecutive letters in reverse order but HNOP is not.
181. (b) D $\overline{\text{P}}$ ST, N $\overline{\text{L}}$ OP, KZM $\overline{\text{L}}$ all are combination of 3 letters and symbol while Q37Q is not.
182. (a) 125, 343, 216 are cubes while 100 is not.
183. (a) $P \xrightarrow{+3} S \xrightarrow{+3} V$
 $D \xrightarrow{+3} G \xrightarrow{+3} J$
 $F \xrightarrow{+3} I \xrightarrow{+3} L$
 But VXB does not follow this pattern.
184. (b) Stable is the place where animal (Horse) lives where as all other are Home of people
185. (d) Only MORU does not follow the pattern of +2, +3, +4 after every Alphabet
186. (d) Only 566 is not a complete square from the given options
187. (c) Only T is consonant else other are vowels.
188. (b) April contains 30 days else all contains 31 days.
189. (a) $28 - 21$ as $28 > 21$ else 1st number is higher than other.
190. (d) Rupee, Pound, Yen are currencies of country.
191. (b) (a) $D - 3 = A$, $A + 4 = E$, $E + 3 = H$
 (b) $K - 2 = I$, $I + 4 = M$, $M + 3 = P$
 (c) $H - 3 = E$, $E + 4 = I$, $I + 3 = L$
 (d) $F - 3 = C$, $C + 4 = G$, $G + 3 = J$
192. (b) $43 - 6 = 37$, $28 - 4 = 24$, $50 - 7 = 43$, $36 - 5 = 31$
 Here except 24 all are prime no.
193. (d) Ally is Antonym of Remaining three.
194. (d) Only FQMV is without any Vowel
195. (d) Difference between $36 - 48$, $56 - 44$ and $78 - 66$ is 12 where as $33 - 64$ is different.
196. (a) The wing, fin and rudder are all parts of an airplane.
197. (b) The group of letters 'JHMX' has no vowel but rest has vowels.
198. (d) Except (d) in all other pairs, second term is reverse of first term.
199. (b) (a) $R \xrightarrow{-1} Q$ $O \xrightarrow{+1} P$
 (b) $I \xrightarrow{+1} J$ $S \xrightarrow{-4} O \longrightarrow$ odd one out
 (c) $C \xrightarrow{-1} B$ $U \xrightarrow{+1} V$
 (d) $Y \xrightarrow{-1} X$ $T \xrightarrow{+1} U$
200. (a) Difference between the number is 17 except (a) $79 - 63 = 16$
201. (a)
202. (c) Except (c) all others are two dimensional shapes while
202. (c) Except (c) all others are two dimensional shapes while sphere is three-dimensional.
203. (a) $\begin{array}{ccc} \text{N} & \text{P} & \text{S} & \text{W} & \text{K} & \text{M} & \text{P} & \text{T} & \text{D} & \text{F} & \text{I} & \text{M} \\ \uparrow & \uparrow & \uparrow & \uparrow & \uparrow & \uparrow & \uparrow & \uparrow & \uparrow & \uparrow & \uparrow & \uparrow \\ +2 & +3 & +4 & & +2 & +3 & +4 & & +2 & +3 & +4 & \end{array}$
 But, $\begin{array}{ccc} \text{D} & \text{F} & \text{O} & \text{U} \\ \uparrow & \uparrow & \uparrow & \uparrow \\ +2 & +9 & +6 & \end{array}$
204. (c) $\begin{array}{ccc} \text{M} & \text{S} & \text{Y} & \text{L} & \text{R} & \text{X} & \text{A} & \text{G} & \text{M} \\ \uparrow & \uparrow & \uparrow & \uparrow & \uparrow & \uparrow & \uparrow & \uparrow & \uparrow \\ +6 & +6 & +6 & +6 & +6 & +6 & +6 & +6 & \end{array}$
 But, $\begin{array}{ccc} \text{I} & \text{N} & \text{U} \\ \uparrow & \uparrow & \uparrow \\ +5 & +7 & \end{array}$
205. (b) As, $2 \textcircled{8} 6 = 2 + 6 = \textcircled{8}$, $4 \textcircled{9} 5 = 4 + 5 = \textcircled{9}$ and $5 \textcircled{8} 3 = 5 + 3 = \textcircled{8}$
 but, $1 \textcircled{6} 6 = 1 + 6 = 7 \neq 6$
206. (c) Captain is odd one out.
207. (d) $99 - 63$ is odd one out.
208. (c) Except, snake, all others are mammals.
209. (b) Except TVW, there is a gap of one letter in a group.
210. (a) Except 69, all others are prime numbers.
211. (b) Except option (b), All others are opposite word.
212. (d) Except CWDX, All others have vowel.
213. (a) $(11)^2 - 1 = 120$
 $(17)^2 + 1 = 290$
 $(21)^2 + 1 = 442$
 $(12)^2 + 1 = 145$
 So, $(11 - 120)$ is an odd number pair.
214. (b) Except Daman, all others are capital.
215. (d) Except 'W' all others are placed at even number position according to alphabet.
216. (a) Except 313, all others are composite number.
217. (c) Except polo, All others are played by sitting.
218. (d) $\begin{array}{ccc} \text{D} & \text{G} & \text{J} & \text{K} & \text{N} & \text{Q} & \text{R} & \text{U} & \text{X} \\ \uparrow & \uparrow & \uparrow & \uparrow & \uparrow & \uparrow & \uparrow & \uparrow & \uparrow \\ +3 & +3 & & +3 & +3 & & +3 & +3 & \end{array}$
 But
 $\begin{array}{ccc} \text{I} & \text{L} & \text{N} \\ \uparrow & \uparrow & \uparrow \\ +3 & +2 & \end{array}$
 So, option (d) is correct answer.
219. (d) Except 49, All are prime numbers
220. (c) Except Deimos (It is a satellite), all others are star systems.
221. (c) Except, xyz, all others are opposite alphabetical sequence.
222. (b) $1919 \Rightarrow 1 + 9 + 1 + 9 = 20$
 $5656 \Rightarrow 5 + 6 + 5 + 6 = 22$
 $6761 \Rightarrow 6 + 7 + 6 + 1 = 20$
 $7760 \Rightarrow 7 + 7 + 6 + 0 = 20$
 Except 5656, Sum of all digit of number is equal to 20.
223. (a) Except 2890, All are cube of a number.
 $(15)^3 = 3375$, $(12)^3 = 1728$, $(11)^3 = 1331$.
224. (c) According to question,
 $\begin{array}{ccc} \text{H} & \xrightarrow{+1} & \text{I} & \text{V} & \xrightarrow{+1} & \text{W} \\ \text{H} & \xrightarrow{+1} & \text{I} & \text{V} & \xrightarrow{+1} & \text{W} \\ \text{F} & \xrightarrow{+1} & \text{G} & \text{K} & \xrightarrow{+1} & \text{L} \\ \text{T} & \xrightarrow{+1} & \text{U} & \text{O} & \xrightarrow{+1} & \text{P} \end{array}$
 But, $\begin{array}{ccc} \text{A} & \xrightarrow{+2} & \text{C} & \text{D} & \xrightarrow{+2} & \text{F} \end{array}$
 So, ACDF does not follow this pattern.
225. (b) Except chess, all others are played at stadium.
226. (d) Except 63, all others are prime number.
227. (c) Only Novel is a type of book.
228. (c) Except Doubtful, all others are similar word.

229. (d) According to question,

$$B \xrightarrow{+3} E \xrightarrow{+3} H \xrightarrow{+3} K$$

$$J \xrightarrow{+3} M \xrightarrow{+3} P \xrightarrow{+3} S$$

$$P \xrightarrow{+3} S \xrightarrow{+3} V \xrightarrow{+3} Y$$

$$\text{But, } E \xrightarrow{+3} H \xrightarrow{+3} K \xrightarrow{+2} M$$

230. (b) Here,

$$A \xrightarrow{+3} D$$

$$E \xrightarrow{+3} H$$

$$J \xrightarrow{+3} M$$

$$\text{But } P \xrightarrow{+4} T$$

231. (d) Here,

$$\frac{48}{12} = 4, \frac{28}{7} = 4, \frac{20}{5} = 4$$

$$\text{But } \frac{55}{11} = 5$$

So, (11 - 55) is odd one out.

232. (d) Here,

$$28 - 12 = 16$$

$$36 - 20 = 16$$

$$58 - 42 = 16$$

$$\text{But, } 90 - 72 = 18$$

So, (90 - 72) is odd one out.

233. (d) According to question,

$$(7)^2 + 1 = 50$$

$$(11)^2 + 1 = 122$$

$$(15)^2 + 1 = 226$$

$$\text{But } (13)^2 + 1 \neq 168 = 170$$

234. (d) According to question,

The pattern is :

$$n \times (n - 1)$$

$$8 \times 7 = 56$$

$$11 \times 10 = 110$$

$$10 \times 9 = 90$$

$$\text{But, } 9 \times 8 \neq 96 = 72$$

235. (d) According to question,

$$K \xrightarrow{+2} M$$

$$P \xrightarrow{+2} R$$

$$T \xrightarrow{+2} V$$

$$\text{But } E \xrightarrow{+3} H$$

236. (d) According to question,

$$R \xrightarrow{-1} Q \xrightarrow{-1} P$$

$$L \xrightarrow{-1} K \xrightarrow{-1} J$$

$$H \xrightarrow{-1} G \xrightarrow{-1} F$$

$$\text{But } E \xrightarrow{-2} C \xrightarrow{-1} B$$

237. (c) Only Gun has bullet.

238. (c) According to question,

Brown is a colour,

Rice is a type of Grain

Iron is a metal

But, fan is not a part of air but it is a electronic device.

239. (d) Except walking - Running, all others are pairs of opposite word.

240. (a) Expensive, costly and valuable are related to the price of any object but 'big' is related to size of any object.

241. (b) every pair is in trqm of $8n : 7n$

In (b) 54 is not in the form of $7n$.

242. (a)
$$\begin{array}{cccc} P & O & W & Z \\ \downarrow & \downarrow & \downarrow & \downarrow \\ -1 & +8 & +3 & \end{array} ; \begin{array}{cccc} K & N & Q & T \\ \downarrow & \downarrow & \downarrow & \downarrow \\ +3 & +3 & +3 & \end{array}$$

$$\begin{array}{cccc} F & I & L & O \\ \downarrow & \downarrow & \downarrow & \downarrow \\ +3 & +3 & +3 & \end{array} ; \begin{array}{cccc} Q & T & W & Z \\ \downarrow & \downarrow & \downarrow & \downarrow \\ +3 & +3 & +3 & \end{array}$$

243. (b)
$$\begin{array}{ccc} 4 : 27 & 16 : 125 & 9 : 64 \\ \downarrow & \downarrow & \downarrow \\ (2)^2 & (3)^3 & (4)^2 & (5)^3 & (3)^2 & (4)^3 \end{array}$$

$$\begin{array}{cc} 49 : 218 \\ \downarrow & \downarrow \\ (7)^2 & (6)^3 + 2 \end{array}$$

Hence, 49 : 218 is odd.

244. (a)
$$\begin{array}{cccc} R & V & Z & D & G \\ \downarrow & \downarrow & \downarrow & \downarrow & \downarrow \\ +4 & +4 & +4 & +3 & \end{array} ; \begin{array}{cccc} D & H & L & P & T \\ \downarrow & \downarrow & \downarrow & \downarrow & \downarrow \\ +4 & +4 & +4 & +4 & \end{array}$$

$$\begin{array}{cccc} U & Y & C & G & K \\ \downarrow & \downarrow & \downarrow & \downarrow & \downarrow \\ +4 & +4 & +4 & +4 & \end{array} ; \begin{array}{cccc} A & E & I & M & Q \\ \downarrow & \downarrow & \downarrow & \downarrow & \downarrow \\ +4 & +4 & +4 & +4 & \end{array}$$

245. (b) Indigo, Orange and Voilet are three colours of rainbow, silver is not a colour seen in rainbow.

246. (c)
$$\begin{array}{cccc} C & G & K, L & P & T, B & F & M, N & R & V \\ \downarrow & \downarrow & \downarrow & \downarrow & \downarrow & \downarrow & \downarrow & \downarrow & \downarrow \\ +4 & +4 & +4 & +4 & +4 & +7 & +4 & +4 & \end{array}$$

Hence, 'BFM' is odd among all.

247. (a) Storm, Cyclone and Flood are natural calamities, whereas disaster is a event that cause a lot of harm or damage.

248. (b) 16, 121, 100 and 81 all are square number, but number of factors of 121 is only 3. that are 1, 11, 121, whereas number of factors of 16, 100 and 81 are more then 3.

249. (a) Except Moon, All are planet. but moon is satellite.

250. (b) Except Ellipse, All are 3-dimensional Figure but ellipse is simple curve.

251. (b) According to question,

$$(678 - 345) = 333 \quad (798 - 456) = 342$$

$$(456 - 123) = 333 \quad (567 - 234) = 333$$

So, option (b) is correct answer.

252. (d) According to question

$$\begin{array}{ccc} & +1 & \\ \downarrow & & \downarrow \\ T & V & U & W \\ \downarrow & & \downarrow & \\ & +1 & & \end{array} \quad \begin{array}{ccc} & +2 & \\ \downarrow & & \downarrow \\ B & F & D & H \\ \downarrow & & \downarrow & \\ & +2 & & \end{array}$$



So, option (d) is correct answer.

253. (c) Except option (c), Digits of all second numbers are Opposite of digits of first numbers.

254. (b) $(7 \times 3) - 10 = 11$, $(9 \times 3) - 10 = 17$, $(13 \times 3) - 10 = 29$
But, $(11 \times 3) - 10 = 23 \neq 25$.

So, option (b) is odd.

255. (b) Option (b) is correct.

Second number is opposite of first number.

256. (b) $Q \xrightarrow{+2} S \xrightarrow{+2} U \xrightarrow{+2} W$,

$B \xrightarrow{+2} D \xrightarrow{+2} F \xrightarrow{+2} H$,

$E \xrightarrow{+2} G \xrightarrow{+2} I \xrightarrow{+2} K$.

But

$M \xrightarrow{+1} N \xrightarrow{+1} O \xrightarrow{+2} Q$

So, option (b) is odd.

257. (d) Except option (d), all second is boundary of first.

258. (b)

259. (b) Except BD, all others are opposite to each other.

260. (b) Except vitamin, all are main source of food but vitamin is catalyst.

261. (a) (a) $4925 : 35 \Rightarrow \sqrt{49} \times \sqrt{25} = 7 \times 5 = 35$

(b) $1625 : 9 \Rightarrow \sqrt{16} + \sqrt{25} = 4 + 5 = 9$.

(c) $4964 : 15 \Rightarrow \sqrt{49} + \sqrt{64} = 7 + 8 = 15$

(d) $1681 : 13 \Rightarrow \sqrt{16} + \sqrt{81} = 4 + 9 = 13$

262. (b) Except submarine, all others can travel on the surface of water, but submarine is a type of ship that can travel under the water as well as on the surface of water.

263. (d) Except FVKO, all others are same pattern. First and second letters are opposite letter and third and fourth letters are opposite.

264. (b) (a) - $T \xrightarrow{+1} S \xrightarrow{+1} R \xrightarrow{+1} Q$

(b) - $P \xrightarrow{+1} O \xrightarrow{+1} N \xrightarrow{+2} L$

(c) - $M \xrightarrow{+1} L \xrightarrow{+1} K \xrightarrow{+1} J$

(d) - $W \xrightarrow{+1} V \xrightarrow{+1} U \xrightarrow{+1} T$

Hence, option (b) is odd letter-cluster.

265. (d) All three are capitals of states except Ahmedabad.

266. (d) $338 - 215 = 123$

$134 - 11 = 123$

$292 - 169 = 123$

$308 - 178 = 130$

267. (c) $T \xrightarrow{+5} Y \xrightarrow{+5} D \xrightarrow{+5} I$

$H \xrightarrow{+5} M \xrightarrow{+5} R \xrightarrow{+5} W$

$Z \xrightarrow{+5} E \xrightarrow{+5} J \xrightarrow{+6} P$

$N \xrightarrow{+5} S \xrightarrow{+5} X \xrightarrow{+5} C$

268. (c) $V \xrightarrow{+6} B \xrightarrow{+6} H \xrightarrow{+6} N$

$A \xrightarrow{+6} G \xrightarrow{+6} M \xrightarrow{+6} S$

$H \xrightarrow{+6} N \xrightarrow{+6} T \xrightarrow{+6} Z$

But,

$I \xrightarrow{+7} P \xrightarrow{+6} V \xrightarrow{+5} A$

Hence, IPVA is different one.

269. (c) Liver, Heart and Lungs are internal part of body but Nose is an external part.

270. (b) Pattern of the given pairs,

$5 \times (5 + 2) = 35$

$7 \times (7 + 2) = 63$

$13 \times (13 + 2) = 195$

But, $19 \times (19 + 2) = 399 \neq 324$

Hence, $19 : 324$ is different one.

271. (d) Option (d) is odd one in the given options
CREST : RCTES

272. (b) odd one = W Z F L

273. (a) $O \xrightarrow{-4} M \xrightarrow{+6} S \xrightarrow{+3} V \xrightarrow{+3} Y$

$O \xrightarrow{+3} R \xrightarrow{+3} U \xrightarrow{+3} X \xrightarrow{+3} A$

$C \xrightarrow{+3} F \xrightarrow{+3} I \xrightarrow{+3} L \xrightarrow{+3} O$

$U \xrightarrow{+3} X \xrightarrow{+3} A \xrightarrow{+3} D \xrightarrow{+3} G$

274. (d) UFAL $\rightarrow 21 + 6 + 1 + 12 = 40$

DWJC $\rightarrow 4 + 23 + 10 + 3 = 40$

BYHE $\rightarrow 2 + 25 + 8 + 5 = 40$

HSNZ $\rightarrow 8 + 19 + 14 + 26 = 67$



JK Chrome

JK Chrome | Employment Portal



Rated No.1 Job Application of India

Sarkari Naukri
Private Jobs
Employment News
Study Material
Notifications



JOBS



NOTIFICATIONS



G.K



STUDY MATERIAL

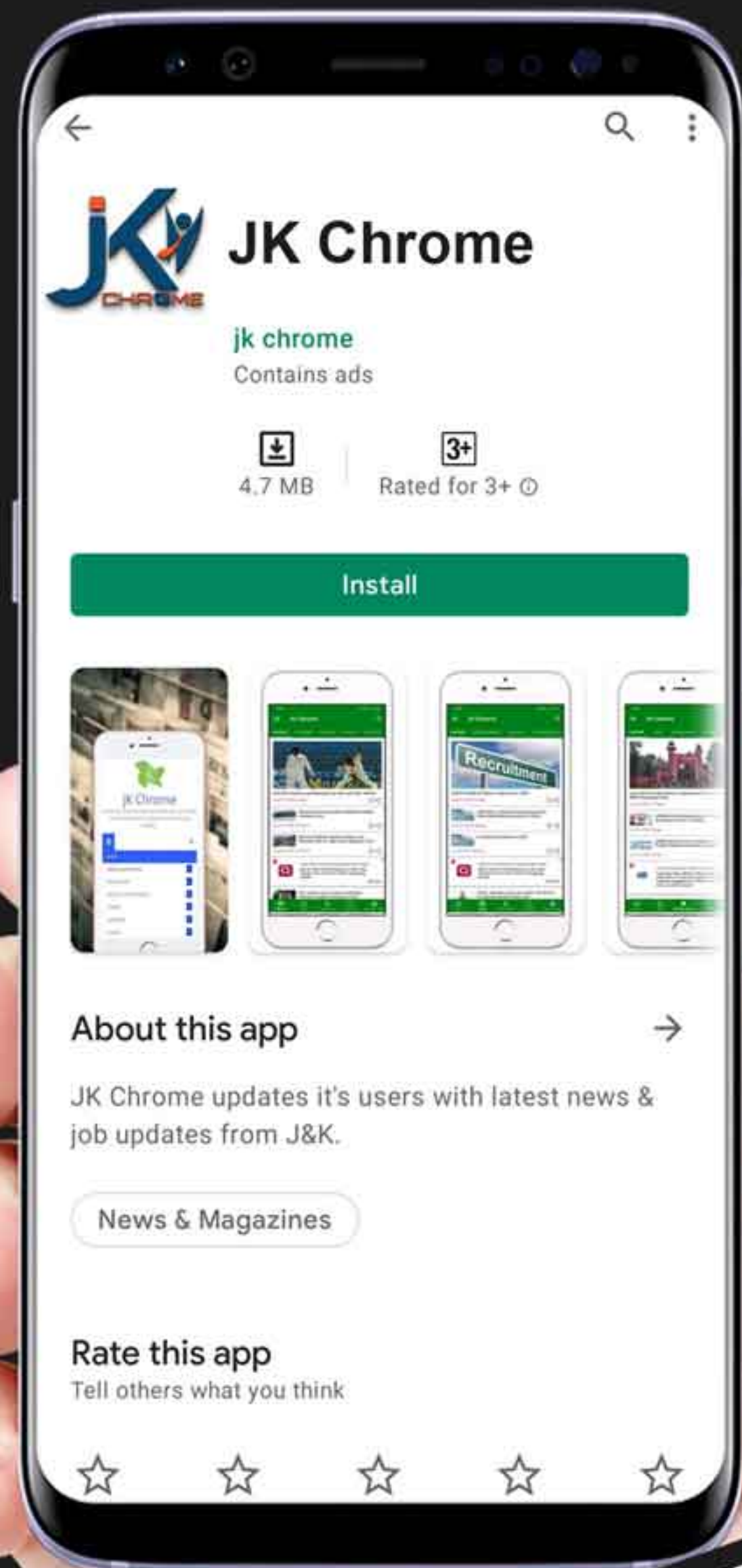

JK Chrome

jk chrome
Contains ads



www.jkchrome.com | Email : contact@jkchrome.com